



DECO LIGNUM

ORMAN ÜRÜNLERİ

www.decolignum.com

İçindekiler / Contents

01-03	Standart Standart
04-05	Zemin Floor
06-09	Kulp Handle
10-21	Entegre Kulp Integrated Handle
22-24	Ray Kapak Sliding Frame
25-26	Dekorasyon Decorative
27-30	Led ve Aksesuar Led and Accessories
31-37	Raf Ve Stand Shelf And Stand
38-41	Mutfak Kitchen
42-43	Ranza Berth
44-45	WC Kabin WC Cabinet
46-50	Ray Kapak Sliding Frame
51-53	Cam Kapak Cupboard Frames
54-56	Kapı ve Kasa Door and Case
57-61	Mekanizma Mechanism
62-63	Mentez Vent

STANDART/STANDART



Pr.No	d	s	kg/m
M 001	8	1	0,060
M 002	8	1,1	0,065
M 003	8	1,5	0,083
M 004	9	1	0,068
M 005	10	1	0,077
M 006	10	2	0,136
M 007	12	1	0,094
M 008	12	4	0,272
M 009	13	1	0,102
M 010	16	1,1	0,140
M 011	16	1,3	0,163
M 012	16	2	0,238
M 013	16	4	0,409
M 014	18	1	0,145
M 015	19	1	0,146
M 016	19	1,3	0,203
M 017	19	2,1	0,302
M 018	19,2	1,5	0,219
M 019	20	1,2	0,193
M 020	20	2	0,306
M 021	21	1,5	0,249
M 022	21,6	2,5	0,405
M 023	22	0,8	0,145
M 024	22	1,5	0,261

Pr.No	d	s	kg/m
M 025	23,4	1	0,190
M 026	25	1,2	0,243
M 027	25	1,5	0,301
M 028	25	2	0,392
M 029	25	2,5	0,479
M 030	25,5	1,2	0,248
M 031	27	1,5	0,326
M 032	27	2,5	0,521
M 033	27	3,9	0,767
M 034	28	5,8	1,096
M 035	29,7	2,3	0,526
M 036	30	1	0,247
M 037	30	2	0,477
M 038	30	3	0,690
M 039	30,2	1,5	0,367
M 040	32	1,2	0,315
M 041	32	1,5	0,390
M 042	32	2	0,511
M 043	32	3,4	0,828
M 044	35	1,2	0,345
M 045	35	1,3	0,373
M 046	35	2	0,561
M 047	35	2,5	0,692
M 048	35	3	0,815

Pr.No	d	s	kg/m
M 049	35,4	14,3	2,569
M 050	38	1	0,315
M 051	40	1,4	0,460
M 052	40	2	0,647
M 053	40	2,5	0,798
M 054	40	5,1	1,515
M 055	40,4	15	3,248
M 056	42	1	0,349
M 057	42	2	0,681
M 058	42,5	2,5	0,852
M 059	44,5	18,9	4,116
M 060	45	2	0,732
M 061	45	5	1,703
M 062	45	17,5	4,097
M 063	48,3	2,5	0,975
M 064	50	1,3	0,539
M 065	50	1,5	0,619
M 066	50	1,8	0,739
M 067	50	2	0,817
M 068	50	2,5	1,010
M 069	50	10,5	3,531
M 070	51	1,1	0,467
M 071	51,2	1,6	0,678
M 072	53	3,5	1,475

Pr.No	d	s	kg/m
M 073	53,6	1,6	0,708
M 074	54	1,8	0,800
M 075	54	5	2,086
M 076	54	16,8	5,312
M 077	55	5	2,128
M 078	59	3,5	1,653
M 079	60	1	0,503
M 080	60	1,5	0,747
M 081	60	2	0,987
M 082	61	1,5	0,760
M 083	64,2	1,5	0,800
M 084	69,6	1,2	0,699
M 085	70	1,5	0,875
M 086	70	3,8	2,142
M 087	70	5	2,767
M 088	72	8	4,359
M 089	75	4	2,418
M 090	76	3	1,865
M 091	76,5	1,2	0,769
M 092	76,9	1,5	0,965
M 093	100	1,2	1,010
M 094	100	4	3,269
M 095	100	5	4,047
M 096	103	2	1,720

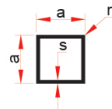

Pr.No	a	s	r	kg/m
M 097	12	2	2,3	0,205
M 098	14	1	-	0,141
M 099	20	1,1	-	0,225
M 100	20	1,8	-	0,355
M 101	20	2	3	0,370
M 102	20,5	2	-	0,401
M 103	25	1,3	-	0,310
M 104	25	1,8	-	0,453
M 105	30	1,5	0,4	0,464
M 106	30	2	-	0,607

Pr.No	a	s	r	kg/m
M 107	30	3	-	0,878
M 108	40	1	-	0,422
M 109	40	1,8	-	0,746
M 110	40	3	-	1,203
M 111	45	2	1	0,932
M 112	50	1,8	1	0,940
M 113	50	3	-	1,529
M 114	60	3	0,5	1,853
M 115	80,3	1,5	-	1,240

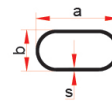

Pr.No	a	b	s	kg/m
M 116	15	7	1,3	0,112
M 117	25	15	1,5	0,254
M 118	30	15	1	0,199
M 119	30	15	1,2	0,239
M 120	40	20	2	0,523
M 121	50	25,4	1,3	0,439
M 122	58	42	2	0,856

STANDART/STANDART

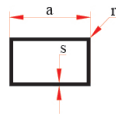

Pr.No	a	b	s	r	kg/m
M 123	18,5	14,5	1,1	-	0,183
M 124	20	10	1,4	-	0,206
M 125	25	17	1	0,4	0,220
M 126	25	17	1,8	0,4	0,375
M 127	30	15	1	0,4	0,233
M 128	30	20	1,5	0,4	0,382
M 129	40	20	1	-	0,314
M 130	40	20	1,2	-	0,374
M 131	40	20	1,9	-	0,579
M 132	50	30	1,5	-	0,626
M 133	50	30	2	0,5	0,824
M 134	50	40	3	-	1,366
M 135	59,7	30,6	3	2	1,389
M 136	64	24	1	-	0,466
M 137	65	25	1,5	0,5	0,710
M 138	70	45	2,5	-	1,490
M 139	73	31	0,9	1	0,498
M 140	75	25	1,7	-	0,890
M 141	75	32	1,1	-	0,597
M 142	75	32	1,8	-	1,009
M 143	80	40	1,5	-	0,920
M 144	80	40	2	-	1,257
M 145	80,5	25	1,5	2,5	0,748
M	100	50	2	-	1,583

Pr.No	a	b	r	kg/m
M 147	12,5	1,5	-	0,051
M 148	14,8	2,5	-	0,100
M 149	15	3	-	0,121
M 150	15	5	-	0,203
M 151	17,2	2,5	-	0,115
M 152	19	3	-	0,154
M 153	19,8	6	-	0,322
M 154	20	3	-	0,162
M 155	20	4	0,6	0,217
M 156	20	5	-	0,271
M 157	20	10	-	0,542
M 158	20	15	-	0,813
M 159	21,6	1,3	-	0,076
M 160	22	10	5	0,538
M 161	25	3	-	0,204
M 162	25	3,7	-	0,251
M 163	30	1,3	-	0,106
M 164	30	3	-	0,244
M 165	30	5	-	0,406
M 166	30	7	1	0,567
M 167	30	10	-	0,813
M 168	35	10	-	0,949
M 169	40	2	-	0,217
M 170	40	3	-	0,325
M 171	40	5	-	0,542

Pr.No	a	b	r	kg/m
M 172	40	10	1	1,081
M 173	40	10	5	1,026
M 174	45	4	-	0,488
M 175	50	2	-	0,271
M 176	50	5	-	0,677
M 177	50	10	-	1,355
M 178	60	5	0,5	0,975
M 179	60	8	-	1,300
M 180	60	10	-	1,626
M 181	60	15	-	2,440
M 182	60	20	-	3,253
M 183	62	6	0,5	1,007
M 184	69	12	1	2,242
M 185	80	10	-	2,168
M 186	85	2,5	-	0,576
M 187	89	5	1	1,204
M 188	100	1,5	-	0,407
M 189	100	8	4	2,131
M 190	100	10	-	2,710
M 191	100	10	5	2,652
M 192	119	5	1	1,610
M 193	120	10	5	3,194
M 194	145	7	-	2,751
M 195	200	12	4	6,467
M 196	200	16	4	8,635

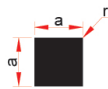

Pr.No	a	r	kg/m
M 197	5	0,5	0,069
M 198	5,1	0,5	0,070
M 199	15	-	0,610

Pr.No	d	kg/m
M 200	4	0,035
M 201	8	0,138
M 202	9,8	0,204
M 203	10	0,213
M 204	11,8	0,296
M 205	12	0,306

Pr.No	d	kg/m
M 206	14,7	0,460
M 207	17	0,615
M 208	20	0,851
M 209	22	1,030
M 210	25	1,330
M 211	32	2,180

Pr.No	d	kg/m
M 212	35	2,607
M 213	40,2	3,439
M 214	45	4,310
M 215	48	4,904
M 216	50	5,321
M 217	53	5,979

Pr.No	d	kg/m
M 218	55	6,438
M 219	59,8	7,611
M 220	61	7,920
M 221	69,8	10,370
M 222	71	10,729

STANDART/STANDART

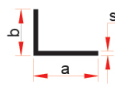

Pr.No	a	b	s	kg/m
	15	15	2	0,151
M 223	15	15	3	0,220
M 224	20	20	1,1	0,116
M 225	20	20	1,1	0,115
M 226	20	20	2	0,208
M 227	25	12	1,2	0,116
M 228	25	18	1,5	0,169
M 229	25	25	1,1	0,145
M 230	25	25	3	0,382
M 231	30	10	1,1	0,116
M 232	30	20	1,2	0,159
M 233	30	30	1,1	0,176
M 234	30	30	1,5	0,238
M 235	30	30	2	0,314
M 236	30	30	3	0,463
M 237	40	10	1,1	0,146
M 238	40	20	1,3	0,207
M 239	40	30	1,2	0,223
M 240	40	35	5	0,948
M 241	40	40	1,2	0,256

Pr.No	a	b	s	kg/m
M 242	40	40	4	0,823
M 243	45	40	2	0,450
M 244	50	25	2	0,395
M 245	50	30	1,2	0,256
M 246	50	40	6	1,366
M 247	50	50	5	1,287
M 248	50	50	8	1,995
M 249	53	18	3	0,553
M 250	60	10	1,2	0,224
M 251	60	20	1,3	0,277
M 252	60	50	4	1,149
M 253	65	15	2	0,419
M 254	65	20	3	0,667
M 255	65	30	5	1,220
M 256	70	50	3	0,951
M 257	80	50	4	1,366
M 258	95,5	80	8,9	4,030
M 259	100	50	4	1,582
M 260	120	50	4	1,799

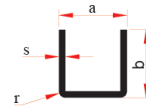

Pr.No	a	b	s	r	kg/m
M 261	8	8	1	1	0,058
M 262	9	10	0,9	1	0,065
M 263	10	11	1,3	-	0,100
M 264	10,5	10,5	1	1	0,079
M 265	12	18	1,5	-	0,183
M 266	17,4	16,5	1,3	-	0,168
M 267	19	20	1	-	0,155
M 268	20	19	1	-	0,151
M 269	20	26	2	-	0,368
M 270	20,5	19	2,5	3	0,352
M 271	20,6	8,1	1,2	1	0,106
M 272	20,6	14,7	1,2	-	0,155
M 273	25,1	15	2	-	0,332
M 274	30	40	6	-	1,594
M 275	32	32	3	-	0,731
M 276	35	35	1,8	-	0,494
M 277	40	35	4	-	1,106
M 278	40	40	3	-	0,927
M 279	40	40	4	-	1,213
M 280	40	40	5	1	1,497
M 281	90	20	2	0,5	0,682
M 282	133,2	42,5	1,4	22	0,759
M 283	208	47	2	5	1,594

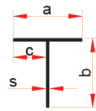

Pr.No	a	b	c	s	kg/m
M 284	20	20	8,5	3	0,301
M 285	30	30	14,3	1,4	0,222
M 286	41,3	55	22	3,5	0,880
M 287	55	55	25	5	1,422

ZEMİN/FLOOR

MK 1101
0,061 kg/m



MK 1102
0,151 kg/m



MK 1103
0,128 kg/m

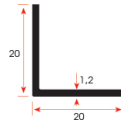

MK 1104
0,160 kg/m

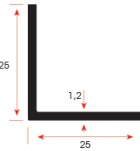

MK 1105
0,191 kg/m

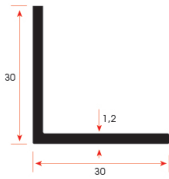

MK 1106
0,256 kg/m

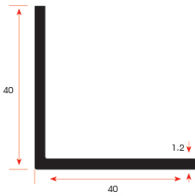

MK 1107
0,207 kg/m

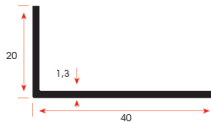

MK 1108
0,085 kg/m



MK 1109
0,105 kg/m



MK 1110
0,110 kg/m



AKS 1110

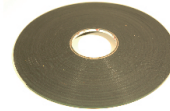

Çift Taraflı Bant 4 mm.

MK 1111
0,170 kg/m



MK 1112
0,135 kg/m

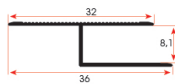

MK 1113
0,120 kg/m



MK 1114
0,105 kg/m

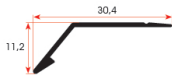

MK 1115
0,213 kg/m

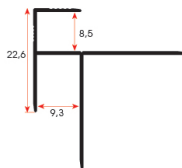

MK 1116
0,190 kg/m

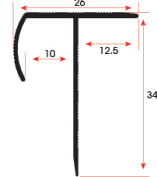

KULP/HANDLE

MK 2201
0,380 kg/m

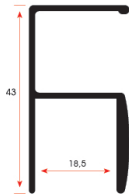

MK 2202
0,305 kg/m

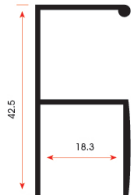

MK 2203
0,255 kg/m

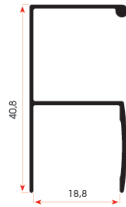

MK 2204
0,410 kg/m

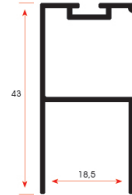

MK 2205
0,315 kg/m

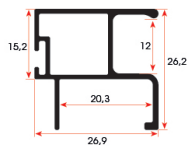

MK 2206
0,410 kg/m

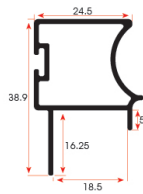

MK 2207
0,320 kg/m

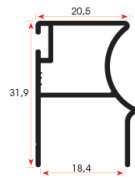

MK 2208
0,630 kg/m

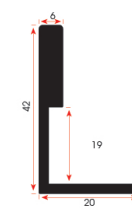

MK 2209
0,280 kg/m

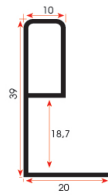

MK 2210
0,325 kg/m

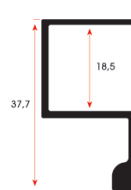

MK 2211
0,235 kg/m

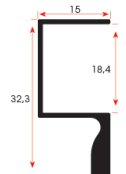

MK 2212
0,345 kg/m



MK 2213
0,260 kg/m



MK 2214
0,210 kg/m

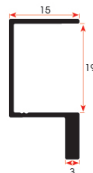

MK 2242
0,475 kg/m

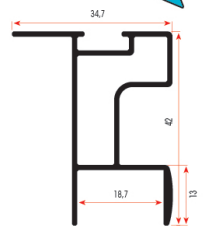

MK 2243
0,275 kg/m

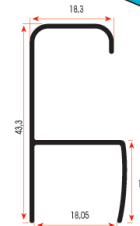

YENI

YENI

KULP/HANDLE

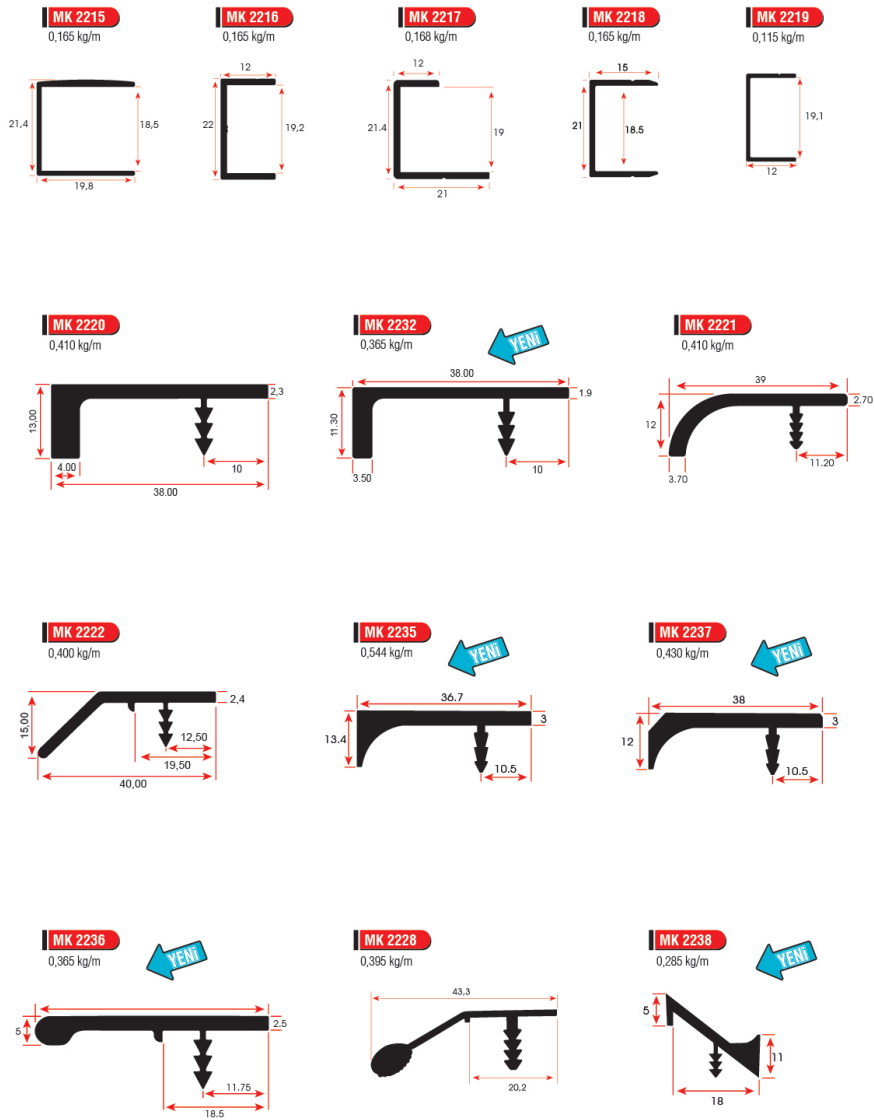

KULP/HANDLE

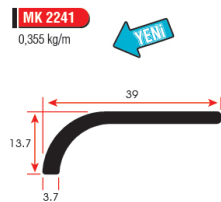
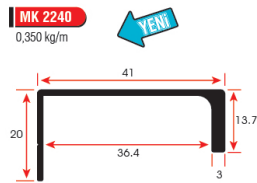
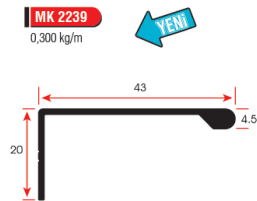
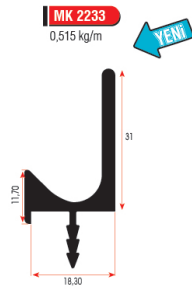
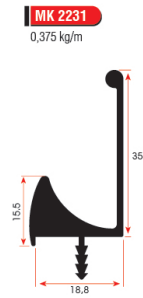
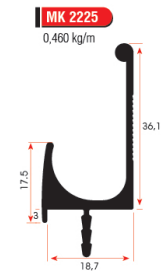
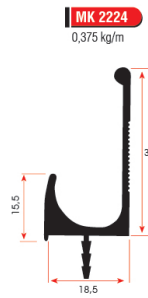
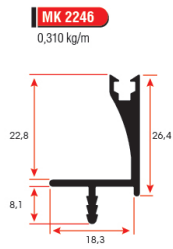

ENTEGRE KULP/INTEGRATED HANDLE

MK 2220 / MK 2232 EKO SERİLERİ

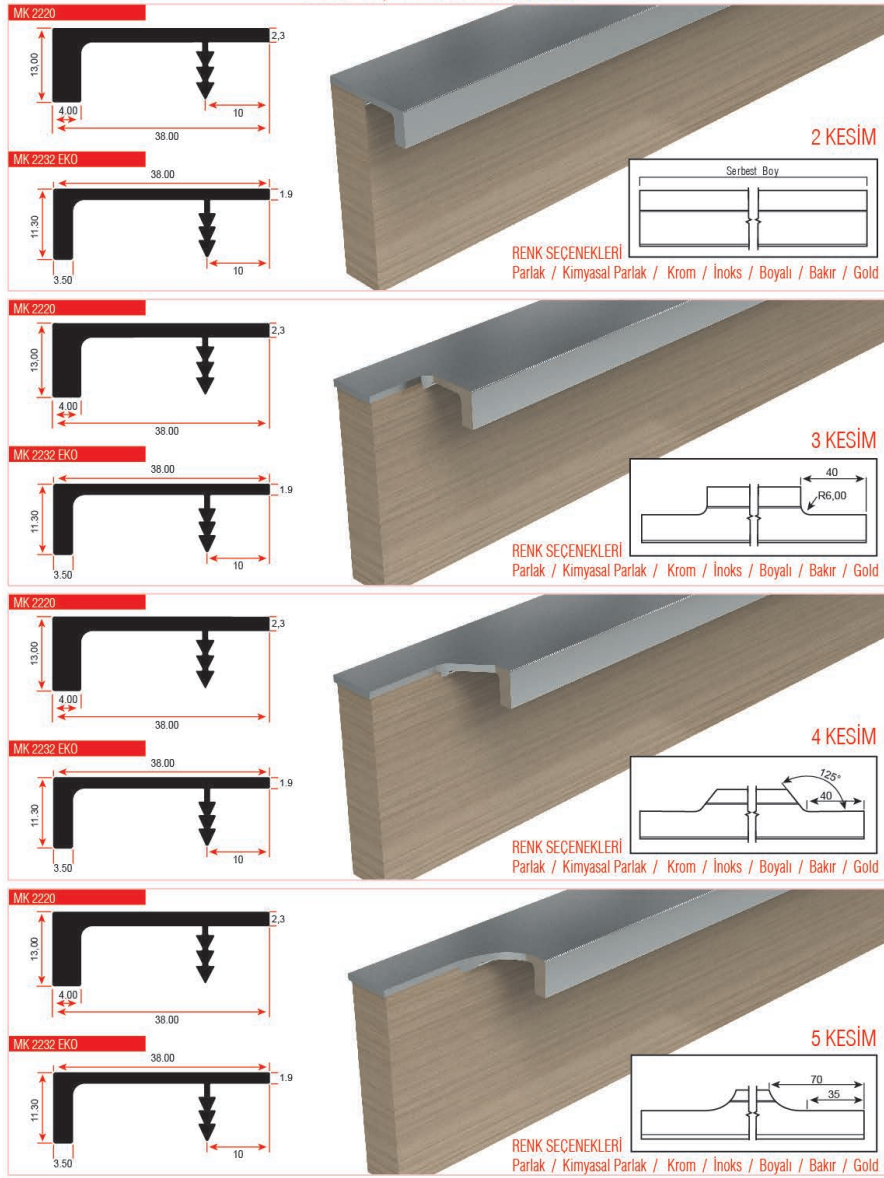

ENTEGRE KULP/INTEGRATED HANDLE

MK 2221 SERİSİ

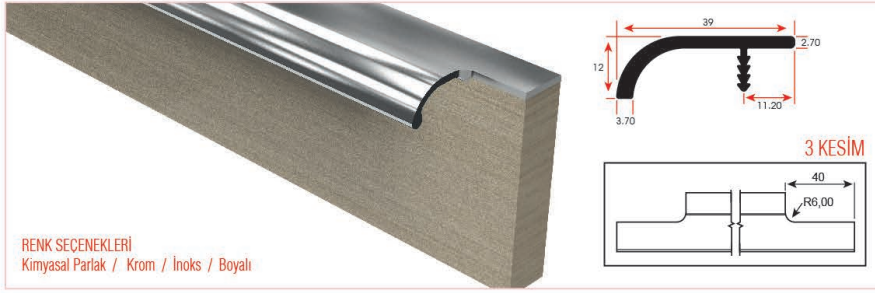
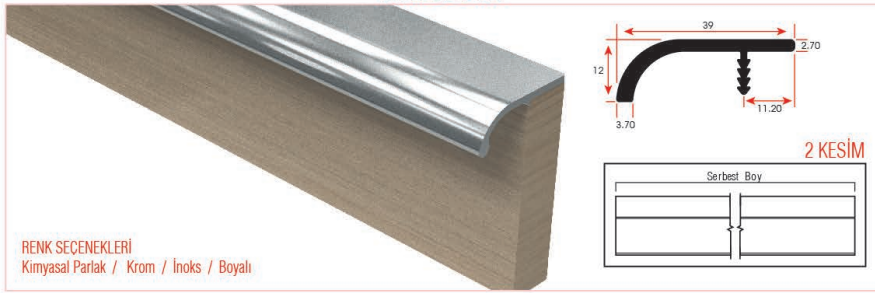

ENTEGRE KULP/INTEGRATED HANDLE

MK 2222 SERİSİ

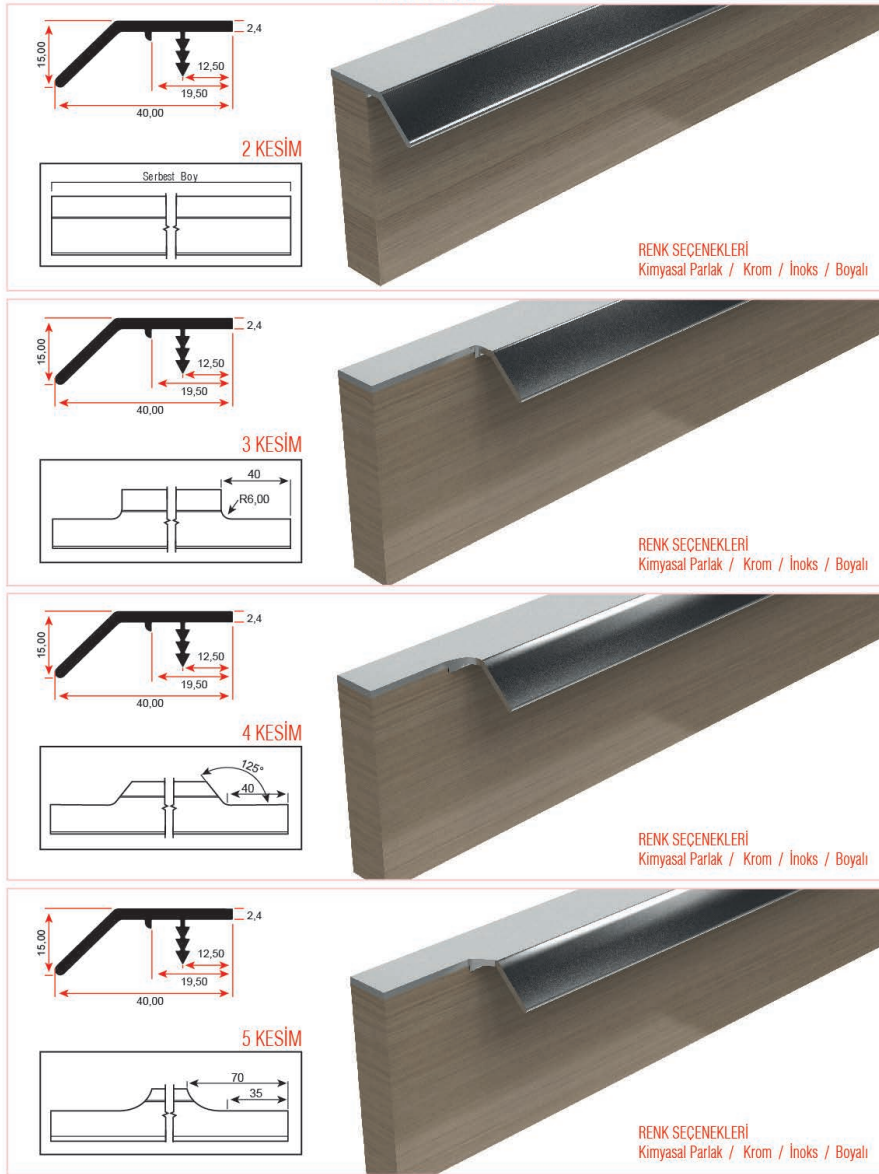

ENTEGRE KULP/INTEGRATED HANDLE

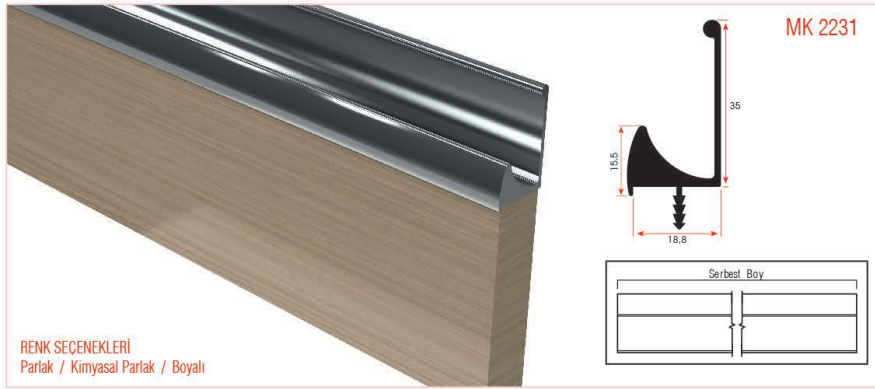
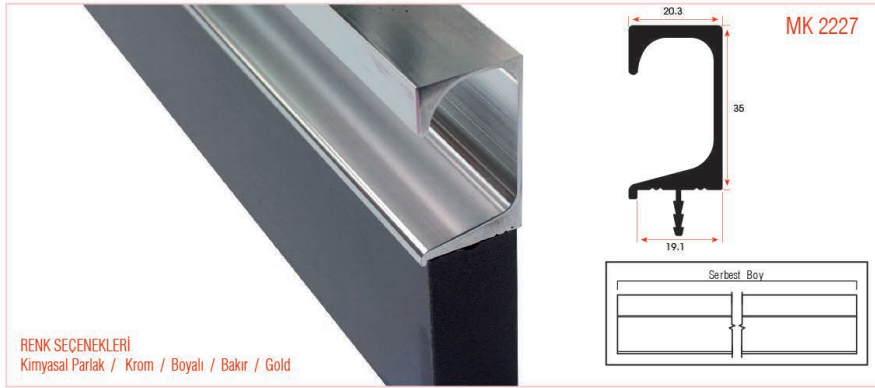
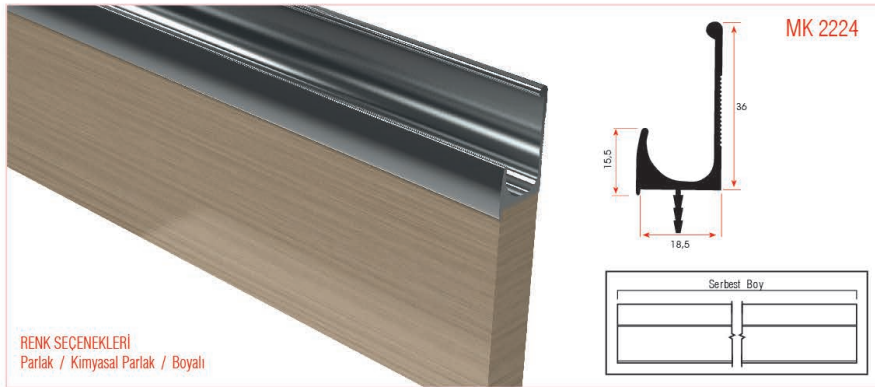

ENTEĞRE KULP/INTEGRATED HANDLE

MK 2236 SERİSİ

KROM 4 KESİM (135°)



İSTENİLDİĞİ TAKDİRDE
2 / 3 / NOLU KESİMLER DE
YAPILABİLMEKTEDİR.

RENK SEÇENEKLERİ
Krom / İnoks / Boyalı

İNOKS 5 KESİM (OVAL KESİM)

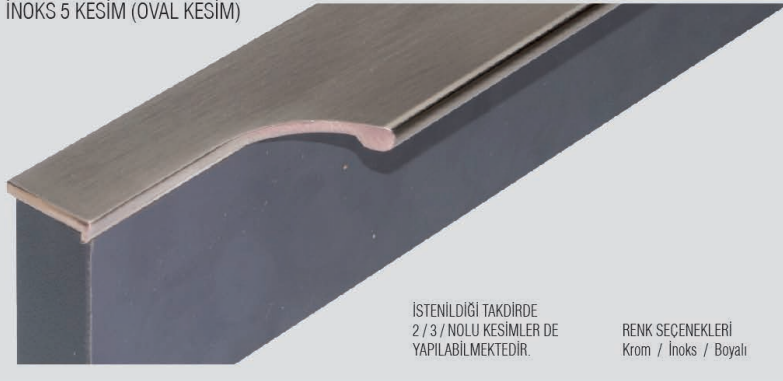

İSTENİLDİĞİ TAKDİRDE
2 / 3 / NOLU KESİMLER DE
YAPILABİLMEKTEDİR.

RENK SEÇENEKLERİ
Krom / İnoks / Boyalı

MK 2236
0,365 kg/m

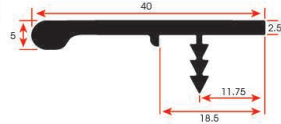

2 KESİM

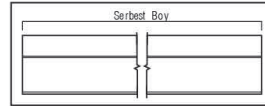

3 KESİM

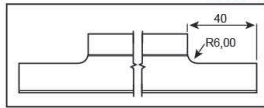

4 KESİM

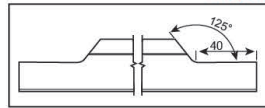

5 KESİM

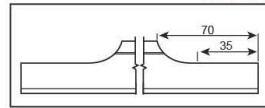

ENTEGRE KULP/INTEGRATED HANDLE

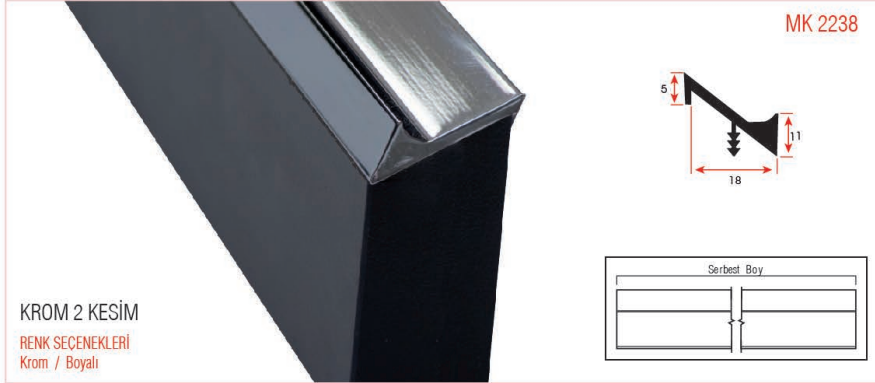
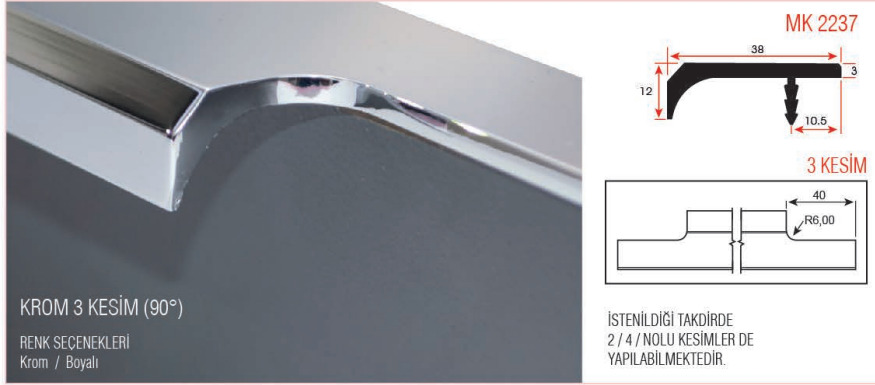
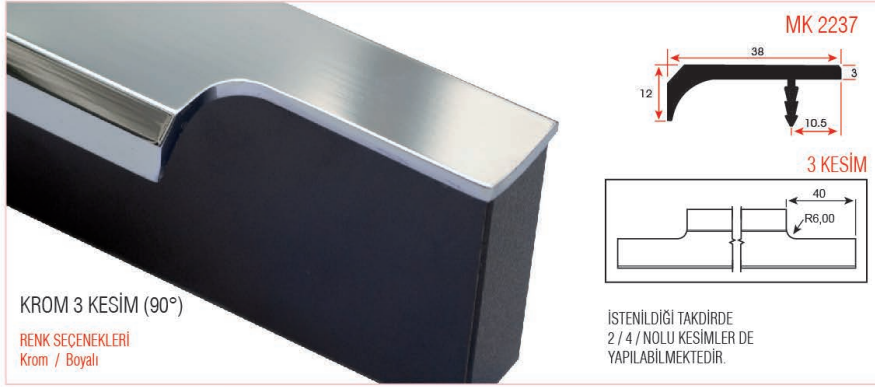

ENTEGRE KULP/INTEGRATED HANDLE

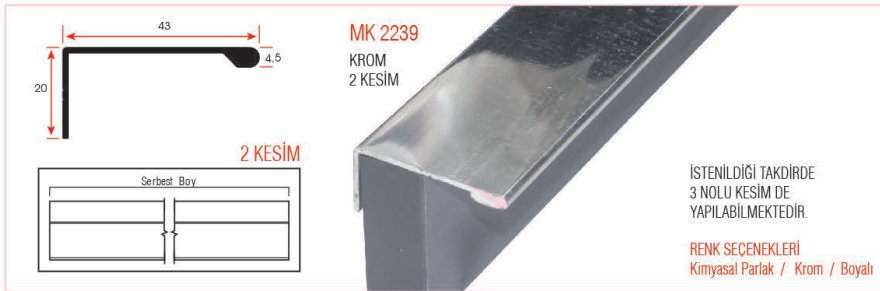

ENTE GRE KULP/INTEGRATED HANDLE

UYGULAMA RESİMLERİ

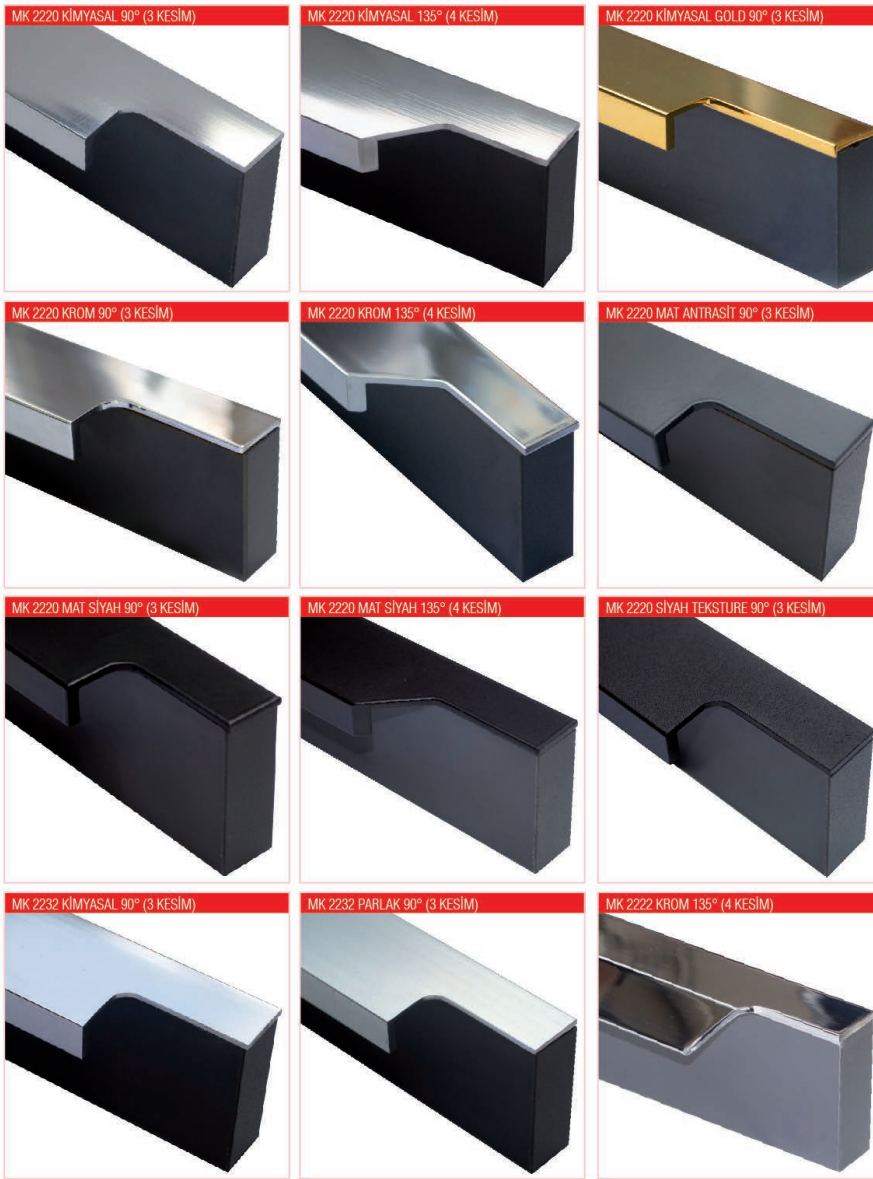

ENTE GRE KULP/INTEGRATED HANDLE

UYGULAMA RESİMLERİ

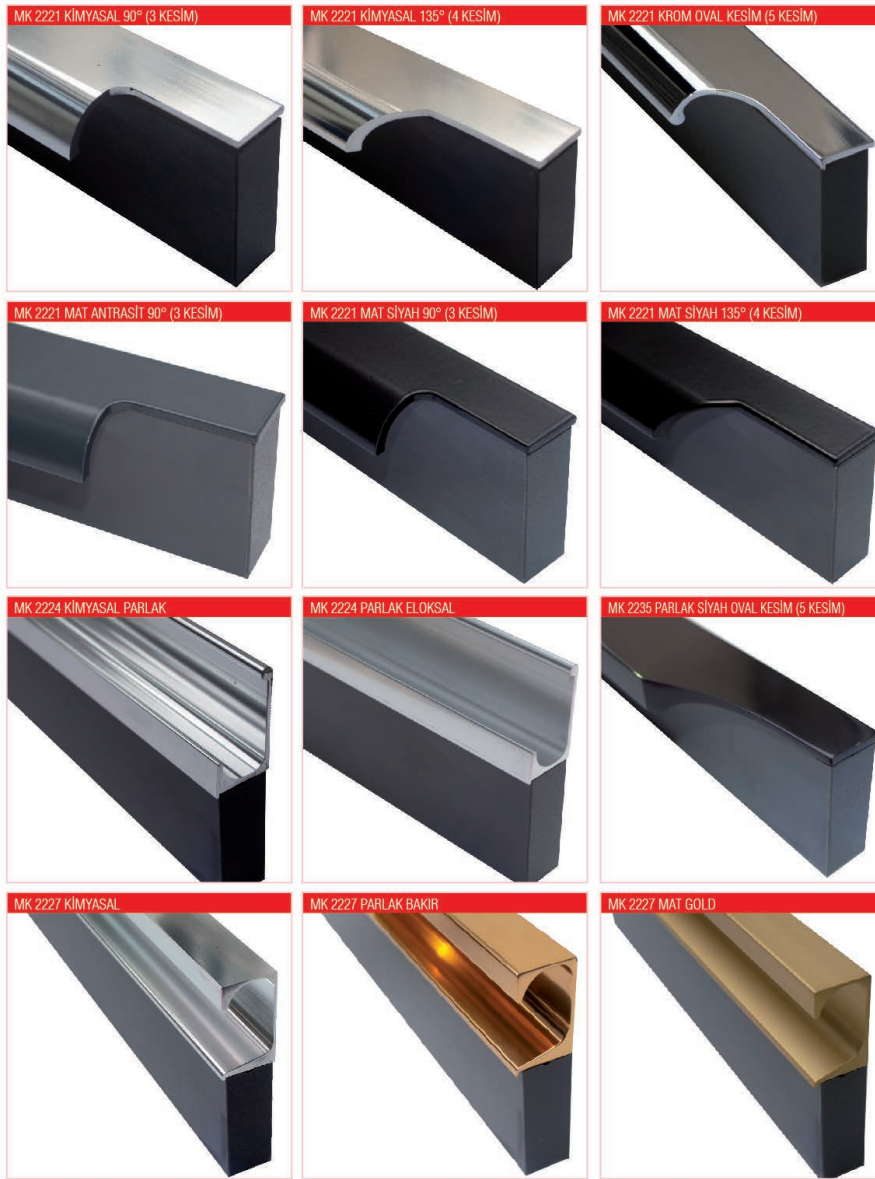

ENTE GRE KULP/INTEGRATED HANDLE

UYGULAMA RESİMLERİ

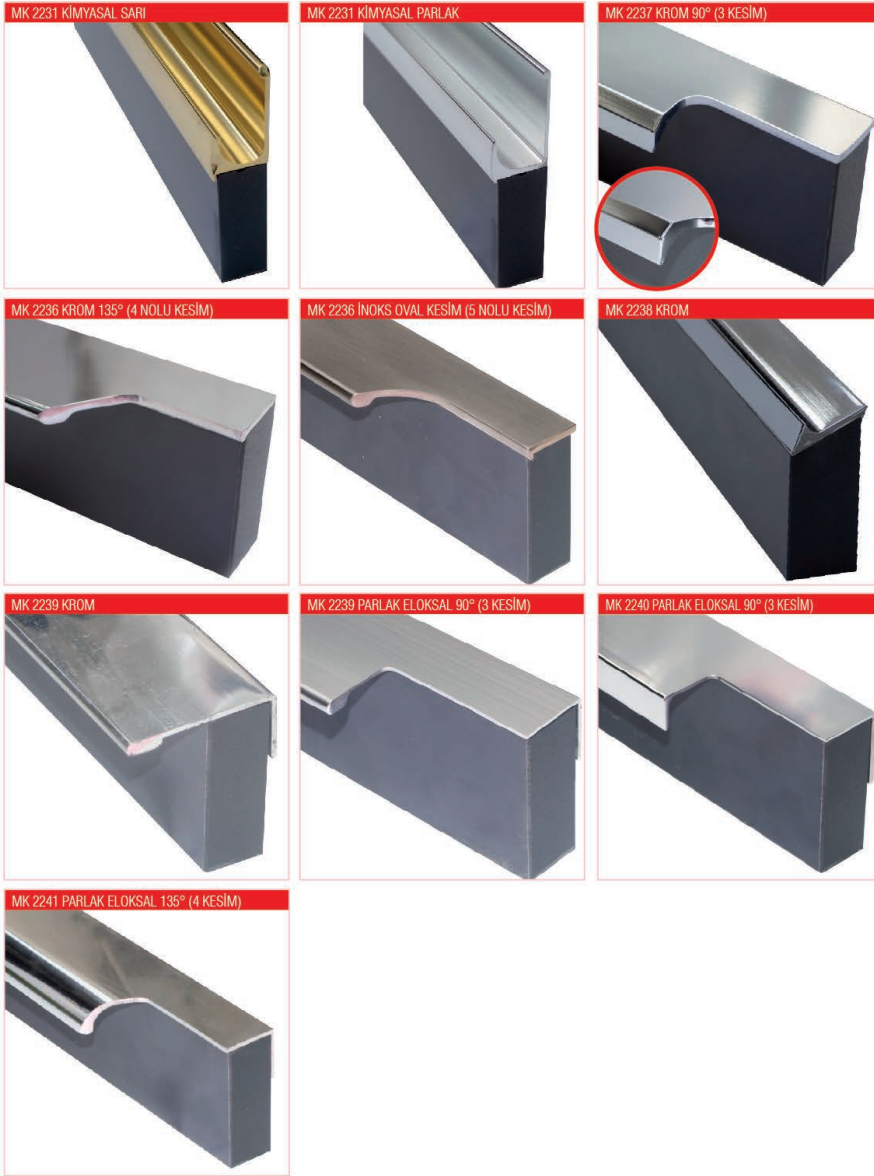

EVYE ALTI ALÜMİNYUM DAMLALIK

ÜRÜN			
Kapak En	Genişlik	Derinlik	Yükseklik
600 mm	564 mm	500 mm	70 mm
700 mm	664 mm	500 mm	70 mm
800 mm	764 mm	500 mm	70 mm
900 mm	864 mm	500 mm	70 mm
1000 mm	964 mm	500 mm	70 mm
1200 mm	1164 mm	500 mm	70 mm

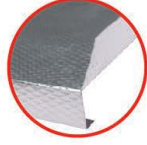

Kenar Koruma Fitilli

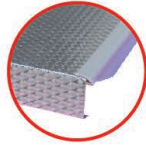

ÜRÜN			
Kapak En	Genişlik	Derinlik	Yükseklik
600 mm	564 mm	500 mm	70 mm
700 mm	664 mm	500 mm	70 mm
800 mm	764 mm	500 mm	70 mm
900 mm	864 mm	500 mm	70 mm
1000 mm	964 mm	500 mm	70 mm
1200 mm	1164 mm	500 mm	70 mm

Özel Ölçülerde de
Üretim Yapılmaktadır.

RAY/RAIL

MK 3301
0,137 kg/m

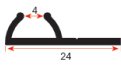

MK 3302
0,085 kg/m



MK 3303
0,116 kg/m



MK 3304
0,118 kg/m

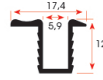

MK 3305
0,070 kg/m



MK 3306
0,520 kg/m

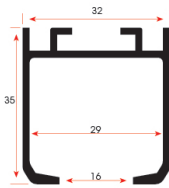

MK 3307
0,620 kg/m

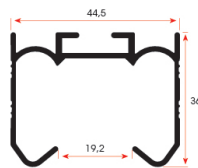

MK 3308
0,485 kg/m



MK 3309
0,410 kg/m

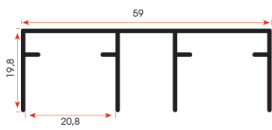

MK 3310
0,285 kg/m

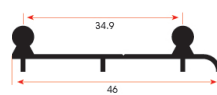

MK 3311
0,185 kg/m

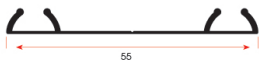

MK 3312
0,200 kg/m

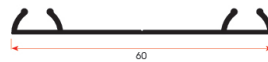

MK 3313
0,265 kg/m

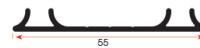

RAY/RAIL

MK 3314

0,229 kg/m

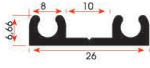

MK 3315

0,324 kg/m

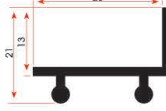

MK 3316

0,780 kg/m

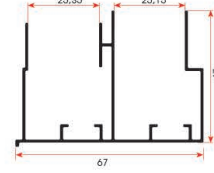

MK 3317

0,550 kg/m

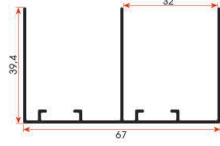

MK 3320

0,740 kg/m

PKM 81 Üst Ray Profili

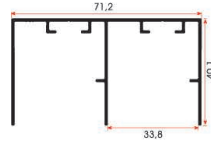

AKS 3320

PKM 81 Mekanizma Takımı



AKS 3318

MK 3318-3319 Mekanizma Takımı



MK 3318

0,740 kg/m

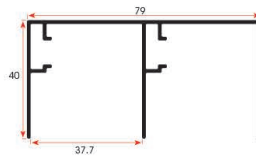

MK 3319

0,360 kg/m

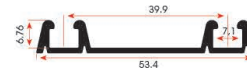

AKS 3311

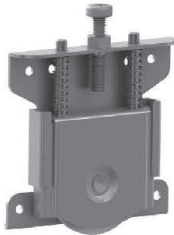

AKS 3312

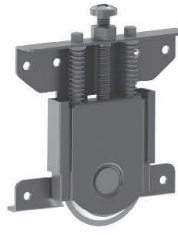

MK 3321

0,600 kg/m

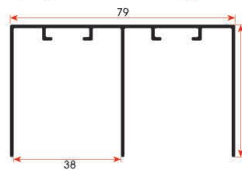

DEKORASYON/DECORATIVE

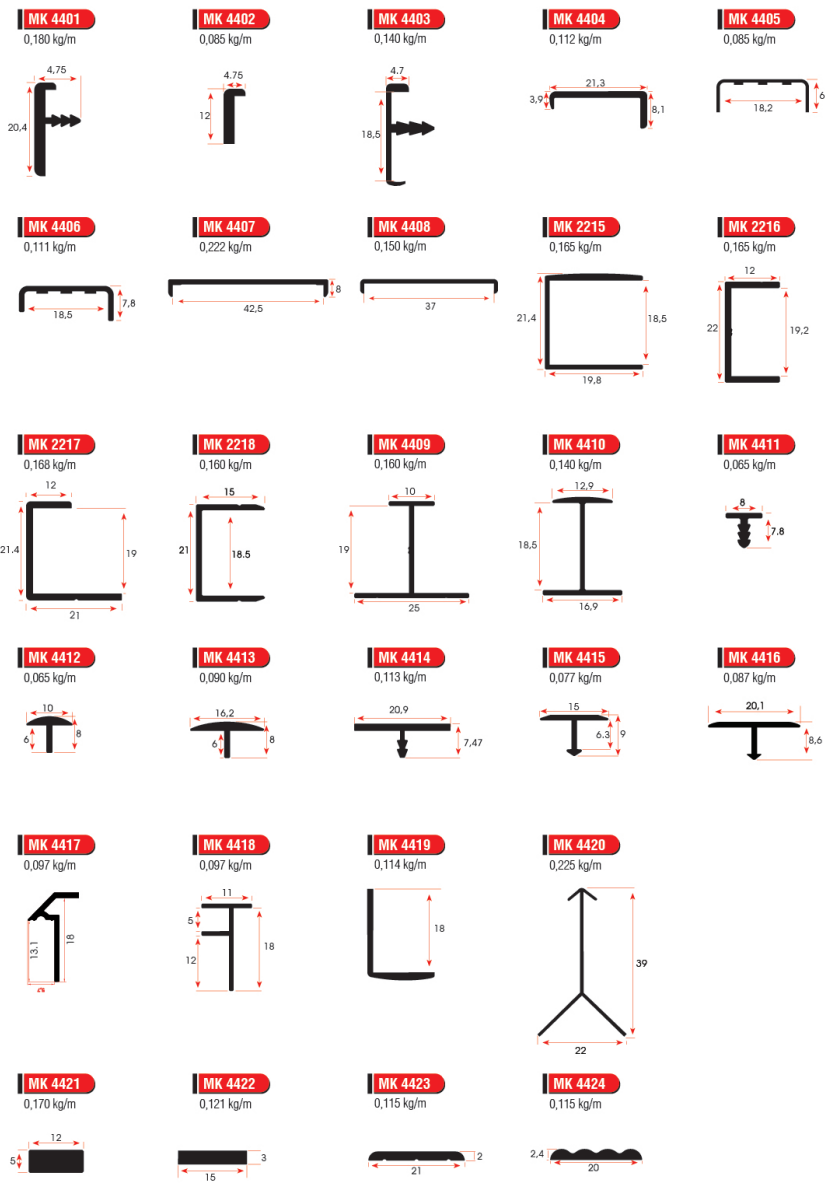

LED/LED

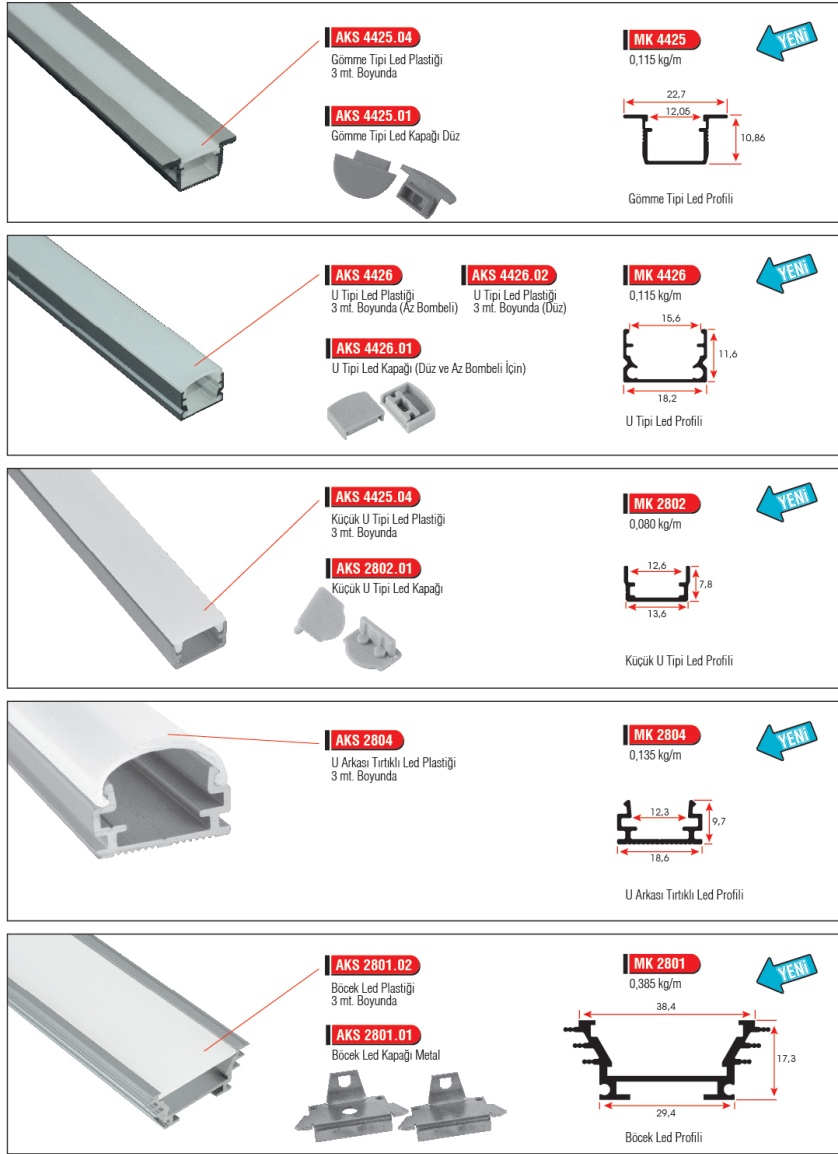

LED/LED

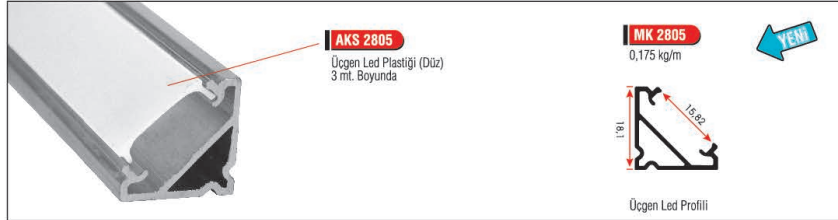
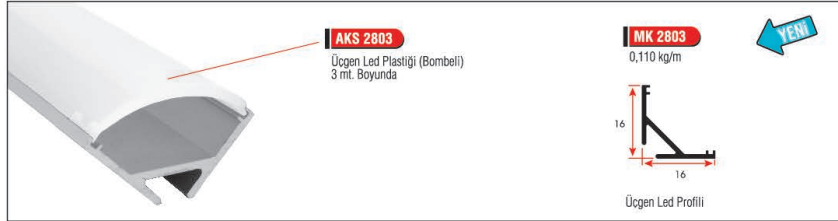
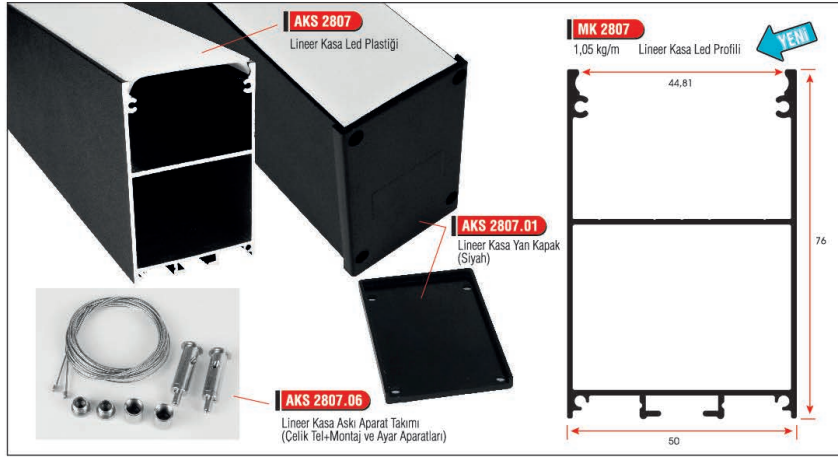

AKSESUAR/ACCESSORIES

MK 4427

0,205 kg/m

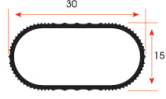

MK 4428

0,140 kg/m

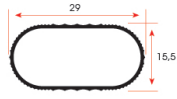

MK 4429

0,200 kg/m

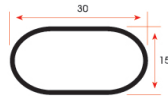

MK 4430

0,120 kg/m

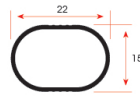

MK 4431

0,175 kg/m

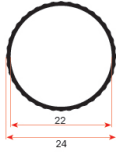

MK 4432

0,093 kg/m



MK 4437

0,090 kg/m



MK 4433

0,080 kg/m



MK 4434

0,085 kg/m



MK 4435

0,060 kg/m



MK 4436

0,324 kg/m

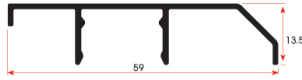

AKS 4436.1

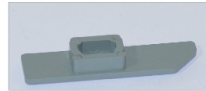

Süpürgelek Bitiş Kapağı

AKS 4436

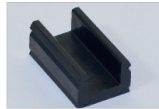

Süpürgelek Bağlantı Plastığı

AKS 4428



Aski Flanşı

RAF VE STAND/SHELF AND STAND

MK 5501
0,170 kg/m

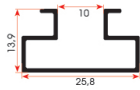

MK 5502
0,213 kg/m

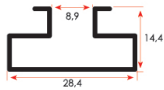

MK 5503
0,237 kg/m

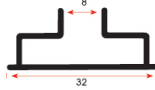

MK 5504
0,320 kg/m

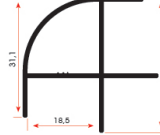

AKS 5504

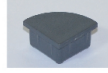

Surta Dönüs ve
Biliş Kapağı

MK 5507 Profilin İşlenmiş Hali



2400 mm 40 Hatve
2800 mm 40 Hatve
2400 mm 50 Hatve
2800 mm 50 Hatve

MK 5508 Profilin İşlenmiş Hali

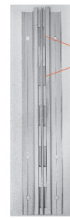

2200 mm 50 Hatve
2500 mm 50 Hatve
2800 mm 50 Hatve
3000 mm 50 Hatve

MK 5508 Profilin İşlenmiş Hali

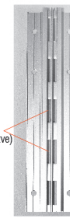

2200 mm 40 Hatve
2500 mm 40 Hatve
2800 mm 40 Hatve
3000 mm 40 Hatve

MK 5505
0,495 kg/m

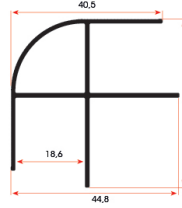

MK 5506
0,298 kg/m

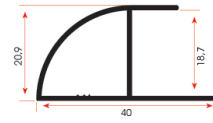

MK 5507
0,410 kg/m

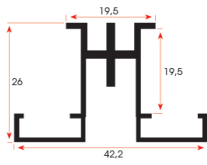

2400 mm 40 Hatve
2800 mm 40 Hatve
2400 mm 50 Hatve
2800 mm 50 Hatve

MK 5508
0,470 kg/m

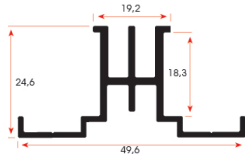

2200 mm 40 Hatve
2500 mm 40 Hatve
2800 mm 40 Hatve
3000 mm 40 Hatve
2200 mm 50 Hatve
2500 mm 50 Hatve
2800 mm 50 Hatve
3000 mm 50 Hatve

AKS 5502



Kanallı Panoya Göre Raf Kancası
10 cm.
15 cm.
20 cm.
25 cm.
30 cm.

AKS 5502.1



Kanallı Panoya Göre Raf Kolu (Krom)
20 cm.
25 cm.
30 cm.

AKS 5502



Kanallı Panoya Göre Eğimli
Boncuklu Baston (Krom)
40 cm.

AKS 5507



Ekonomik Raf Kolu (Beyaz)
30 cm.
50 Hatveye Göre

AKS 5507.1



Ekonomik Raf Kolu (Krom)
30 cm.
40-50 Hatveye Göre

AKS 5507.2



Ters Raf Kolu (Krom)
30 cm.
35 cm.
40 cm.
40-50 Hatveye Göre

DİKME SİSTEMLERİ GRUBU



ÜRÜN AÇIKLAMALARI

Ecoset Tekli Ray	Beyaz	200 cm
Ecoset Çiftli Ray	Beyaz	200 cm
F Dikme 30x50x1,5mm	50 Hatve	200 cm
F Dikme 30x60x2mm	50 Hatve	200 cm
Kare Dikme 50 hatve 2 mm		200 cm
Konik Dikme 40 hatve 1,5 mm		200 cm
Konik Dikme 50 hatve 2 mm		200 cm
Konik Dikme 50 hatve Oval		200 cm

RAF KOLLARI GRUBU



RAF VE STAND/SHELF AND STAND

U ASKI VE TRAVERS GRUBU



ÜRÜN AÇIKLAMALARI

Travers Oval	15x30x1 mm	70 cm Krom
Travers Oval	15x30x1 mm	80 cm Krom
Travers Oval	15x30x1 mm	90 cm Krom
Travers Oval	15x30x1 mm	100 cm Krom

Travers	10x30x1.2 mm	70 cm Krom
Travers	10x30x1.2 mm	80 cm Krom
Travers	10x30x1.2 mm	90 cm Krom
Travers	10x30x1.2 mm	100 cm Krom

ÜRÜN AÇIKLAMALARI

Travers	20x30x1 mm	70 cm Krom
Travers	20x30x1 mm	80 cm Krom
Travers	20x30x1 mm	90 cm Krom
Travers	20x30x1 mm	100 cm Krom

Travers	20x40x1 mm	70 cm Krom
Travers	20x40x1 mm	80 cm Krom
Travers	20x40x1 mm	90 cm Krom
Travers	20x40x1 mm	100 cm Krom

KPG - ATG ASKI GRUBU



DÜZ ASKI



PİMLİ ASKI



KADEMELİ ASKI



ŞELALE ASKI



BONGUÇUKLU ASKI

Kanallı Panoya Göre Eğimli
40 cm Krom

ÜRÜN AÇIKLAMALARI

KPG Düz Askı	10x30x1.2 mm	40 cm
KPG Düz Askı Oval	15x30 mm	40 cm
KPG Pimli Askı	10x30x1.2 mm	40 cm
KPG Pimli Askı Oval	15x30 mm	40 cm
KPG Kademeli Askı	10x30x1.2 mm	40 cm
KPG Kademeli Askı Oval	15x30 mm	40 cm

ATG Düz Askı	10x30x1.2 mm	40 cm
ATG Düz Askı Oval	15x30 mm	40 cm
ATG Pimli Askı	10x30x1.2 mm	40 cm
ATG Pimli Askı Oval	15x30 mm	40 cm
ATG Kademeli Askı	10x30x1.2 mm	40 cm
ATG Kademeli Askı Oval	15x30 mm	40 cm

ÜRÜN AÇIKLAMALARI

40 Hatve İçin Düz Askı	10x30x1.2 mm	40 cm
40 Hatve İçin Düz Askı Oval	15x30 mm	40 cm
40 Hatve İçin Pimli Askı	10x30x1.2 mm	40 cm
40 Hatve İçin Pimli Askı Oval	15x30 mm	40 cm
40 Hatve İçin Kademeli Askı	10x30x1.2 mm	40 cm
40 Hatve İçin Kademeli Askı Oval	15x30 mm	40 cm

RAF VE STAND/SHELF AND STAND

SPOT GRUBU

KPG DÜZ ETİKETLİ SPOTLAR

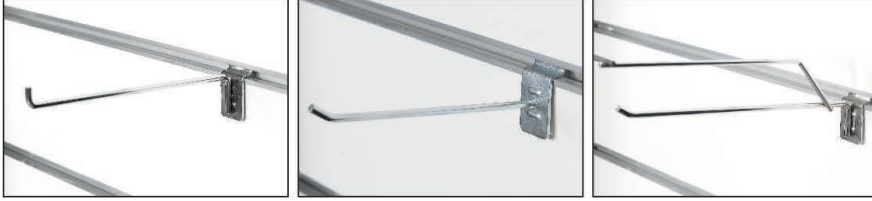

DSG DÜZ ETİKETLİ SPOTLAR



ATG NİKEL SPOTLAR



DUVARA MONTE KANCA

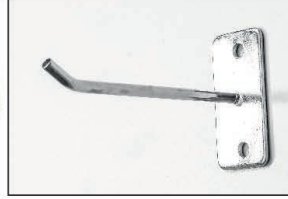

ÜRÜN AÇIKLAMALARI
KROM SPOT GRUBU (KPG-ATG-DSG)
Düz Tel Spot 10 cm
Düz Tel Spot 15 cm
Düz Tel Spot 20 cm
Düz Tel Spot 25 cm
Düz Tel Spot 30 cm

Etiketli Tel Spot 10 cm
Etiketli Tel Spot 15 cm
Etiketli Tel Spot 20 cm
Etiketli Tel Spot 25 cm
Etiketli Tel Spot 30 cm

ÜRÜN AÇIKLAMALARI
ÇİNKO SPOT GRUBU (KPG-DSG-DUVARA MONTE)
Düz Tel Spot 10 cm
Düz Tel Spot 15 cm
Düz Tel Spot 20 cm
Düz Tel Spot 25 cm
Düz Tel Spot 30 cm
Sekiz Delik Takım

MUTFAK/KITCHEN

MK 6601
0,250 kg/m



MK 6602
0,245 kg/m

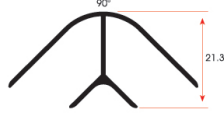

MK 6603
0,168 kg/m



MK 6604
0,250 kg/m

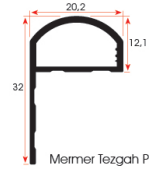

MK 2246
0,310 kg/m

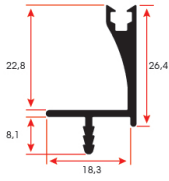

MK 6605
0,455 kg/m



MK 6606
0,319 kg/m



MK 6617
0,425 kg/m

YENI

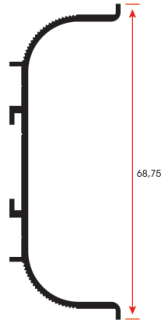

MK 6616
0,290 kg/m

YENI

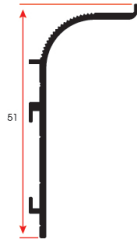

AKS 6601

Eyeye Profili
Bağlantı Plastiği



AKS 2223

Gizli Kulp Fitolu

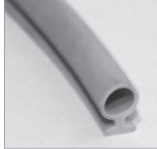

AKS 6605.1

Gizli Kulp
Bağlantı Elemanı



AKS 6603

Hareketli Baza
Dönüş Fitolu

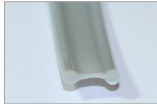

AKS 6611.1

Baza Fitolu

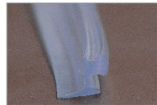

AKS 6611

Baza Klipsi



MUTFAK/KITCHEN

AKS 6607



AKS 6607.1

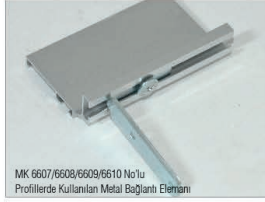

Uygulama Görseli

AKS 6608



AKS 6608.1



MK 6611

0,400 kg/m

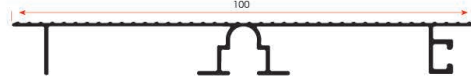

MK 6612

0,440 kg/m

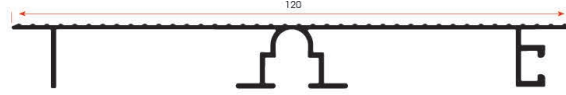

MK 6613

0,625 kg/m

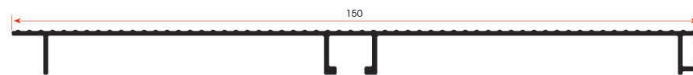

MUTFAK/KITCHEN

MK 6614
0,450 kg/m

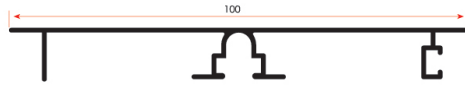

MK 6615
0,475 kg/m

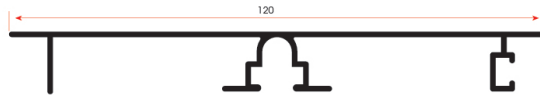

MK 6616
0,680 kg/m

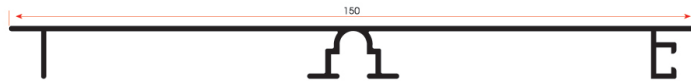

MK 6617
0,490 kg/m

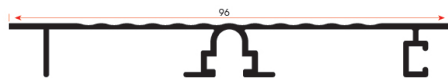

MK 6618
0,550 kg/m

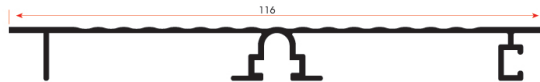

MK 6619
0,625 kg/m

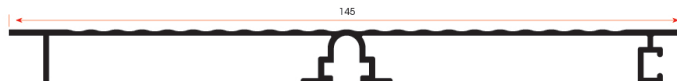

RANZA/BERTH

MK 7701
0,630 kg/m

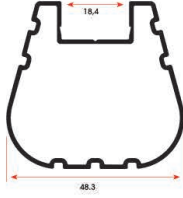

MK 7702
0,630 kg/m

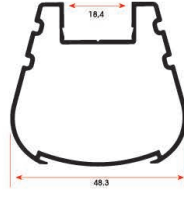

MK 7703
0,450 kg/m

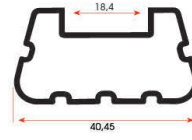

MK 7704
1,100 kg/m

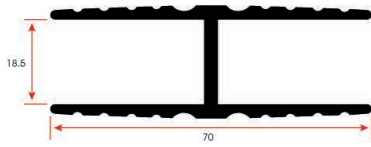

AKS 7701

Ranza Ara Takoz



MK 7701.1

Ranza Büyük Kapak



AKS 7703

Ranza Mini Kapak



WC KABİN/WC CABINET

ALÜMİNYUM AKSESUARLAR

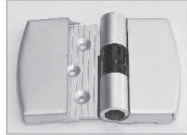

Kabin Kapı Topuzu

Ayak

Menteşe



Kapı Askısı

Kabin Sürgü

Kabin Sürgü Takımı

PASLANMAZ AKSESUARLAR



Menteşe

Kilit

Kabin Kapı Topuzu



Alüminyum Kapı Askısı



Askı Stoperi



Ayak

MK 7705

0,465 kg/m

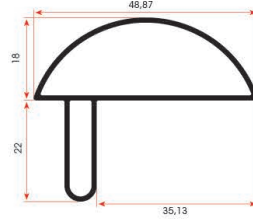

MK 7706

0,230 kg/m

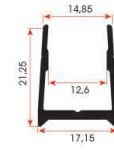

MK 7707

0,205 kg/m

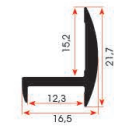

MK 6602

0,245 kg/m

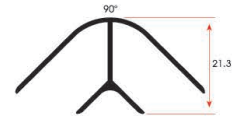

RAY KAPAK/SLIDING FRAME

MK 8801
0,480 kg/m

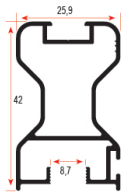

MK 8802
0,400 kg/m

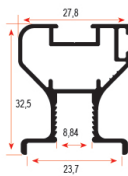

MK 8803
0,425 kg/m

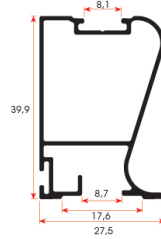

MK 8804
0,325 kg/m

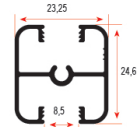

MK 8805
0,265 kg/m

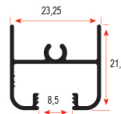

MK 8806
0,570 kg/m

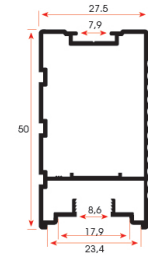

MK 8807
0,515 kg/m

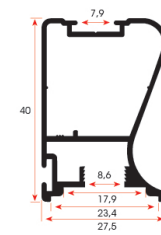

MK 8808
0,470 kg/m

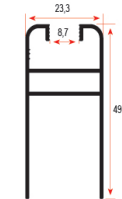

MK 8809
0,550 kg/m

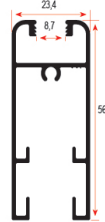

MK 8810
0,220 kg/m

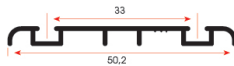

MK 8812
0,360 kg/m



MK 8811
0,250 kg/m



MK 8813
0,455 kg/m

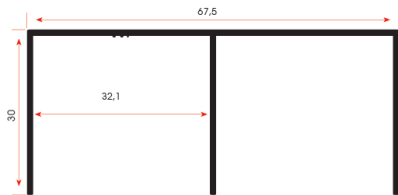

MK 8814
0,550 kg/m

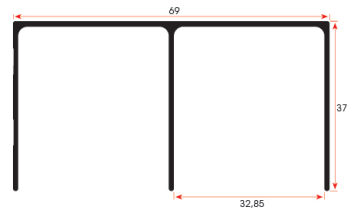

RAY KAPAK/SLIDING FRAME

18 mm. Sürge Kapak Sistemi

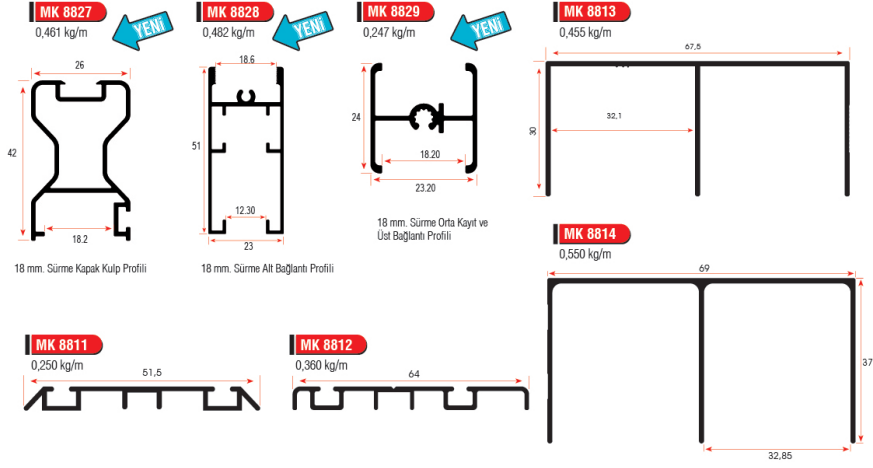

UYGULAMA RESİMLERİ

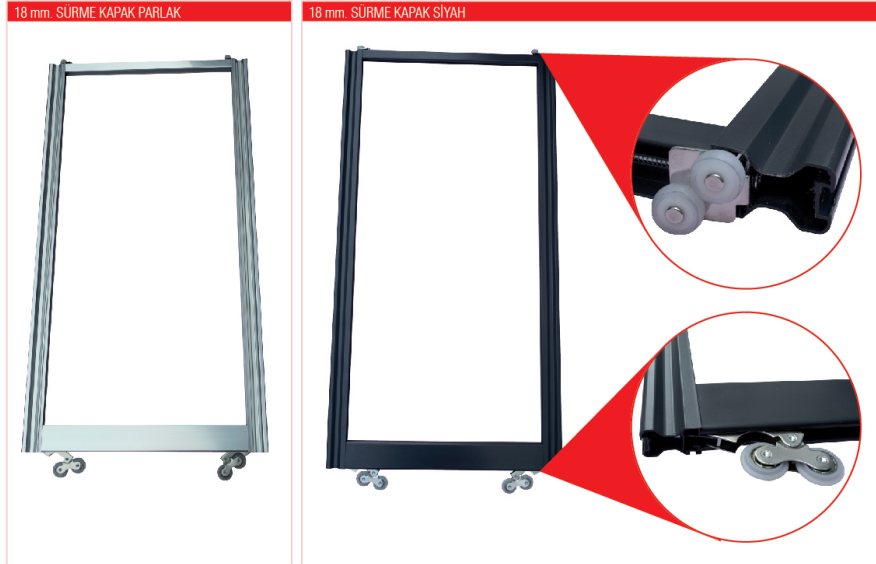

RAY KAPAK/SLIDING FRAME

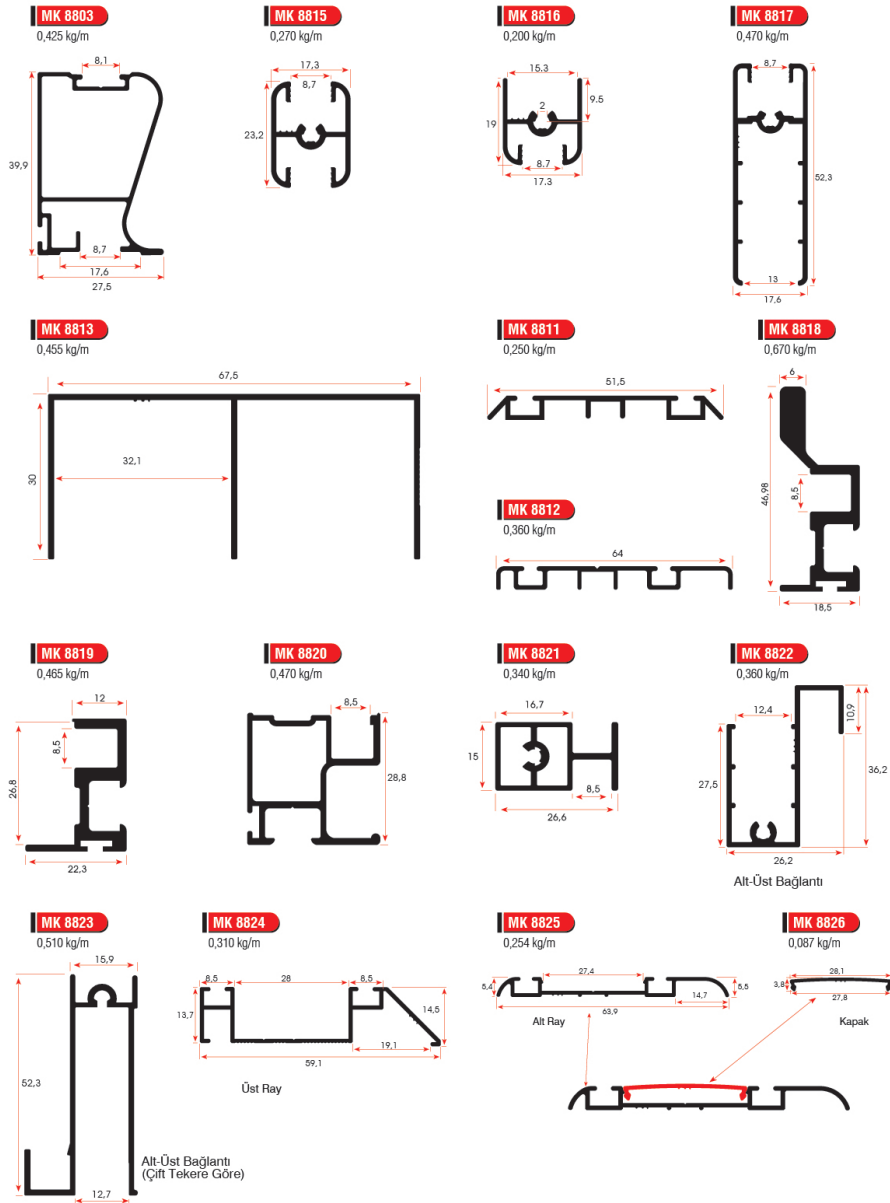

RAY KAPAK/SLIDING FRAME

AKS 8814

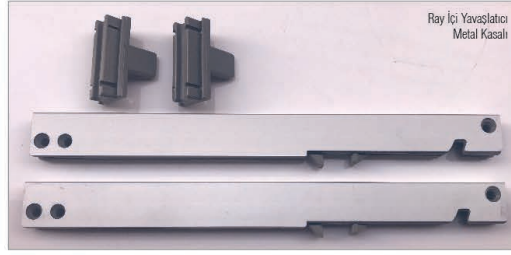

AKS 8811

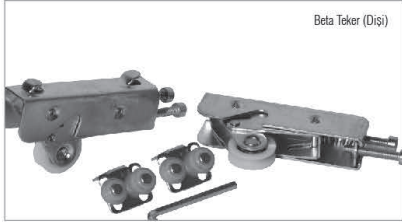

AKS 8811.1

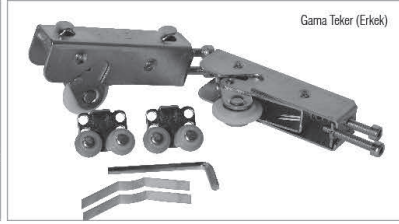

AKS 8822

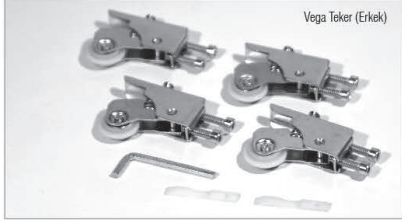

AKS 8812

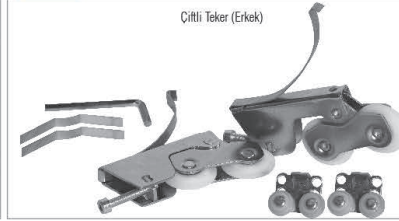

AKS 8804



AKS 8804.1

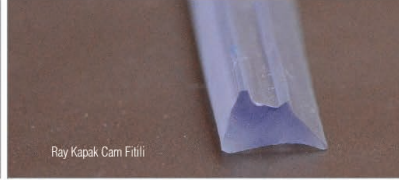

AKS 8801



AKS 8801.1



AKS 8801.2



CAM KAPAK/CUPBOARD FRAMES

MK 8901

0,287 kg/m

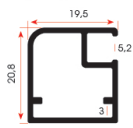

MK 8902

0,282 kg/m

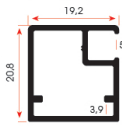

MK 8903

0,380 kg/m

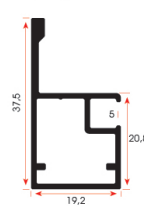

MK 8904

0,430 kg/m

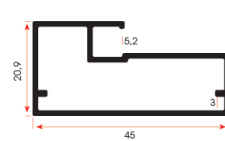

MK 8905

0,450 kg/m

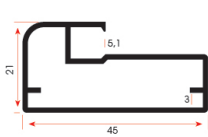

MK 8906

0,372 kg/m

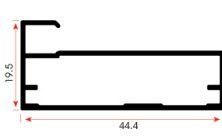

MK 8907

0,450 kg/m

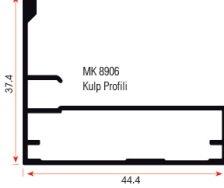

MK 2244

0,275 kg/m



MK 8908

0,425 kg/m

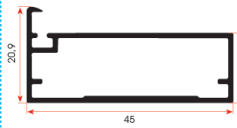

MK 8909

0,475 kg/m

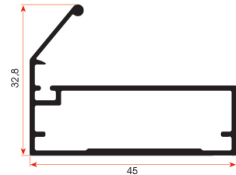

AKS 8901

Küçük Metal Köşe



AKS 8904

Büyük Metal Köşe



AKS 8901.1



Devede Boyunu Profil Mentese

AKS 8901.2



Düz Profil Mentese

AKS 8904.1



Devede Boyunu Tas Mentese

AKS 8904.2



Düz Tas Mentese

MK 8913

0,420 kg/m

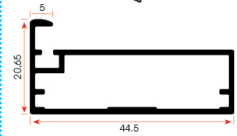

MK 8914

0,485 kg/m

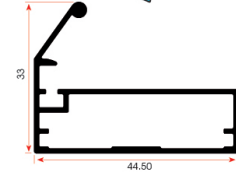

AKS 8901.3

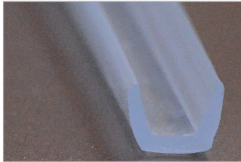

AKS 8901.4

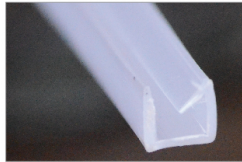

CAM KAPAK/CUPBOARD FRAMES

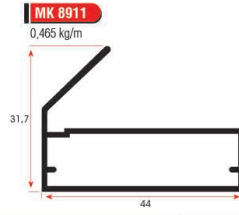
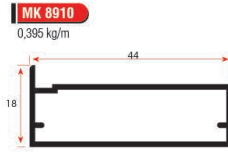
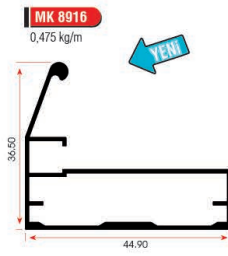
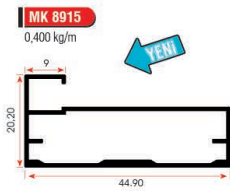

UYGULAMA RESİMLERİ



KAPI VE KASA/DOOR AND CASE

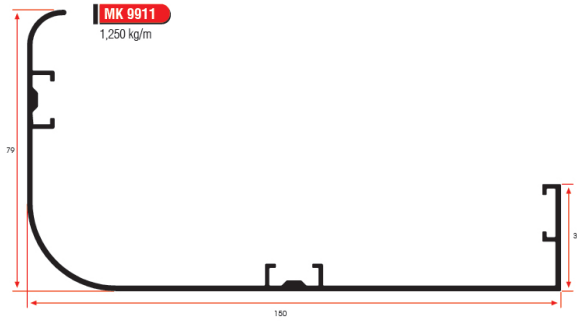
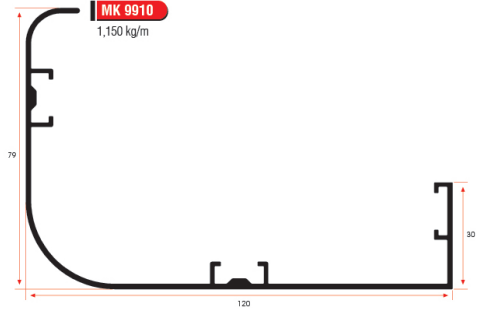
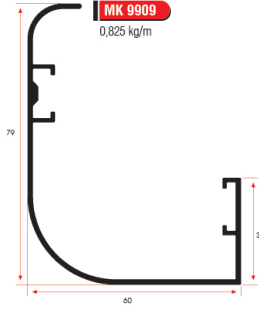
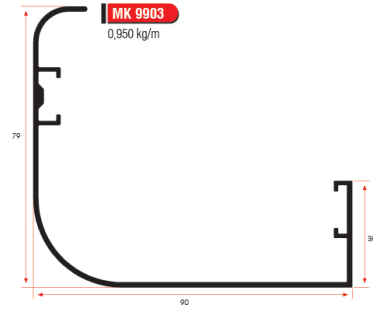
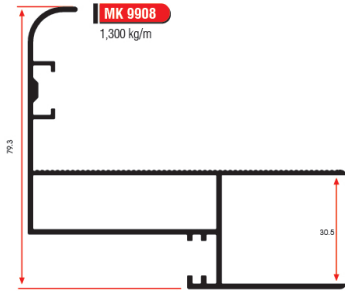

AKS 9901

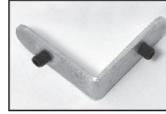

Kapı Kasası Bükümlü Köşe

AKS 9902

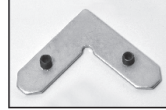

Kapı Kasası L Köşe

AKS 9903

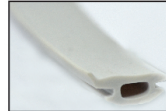

Kapı Kasası Filteli

KAPI VE KASA/DOOR AND CASE

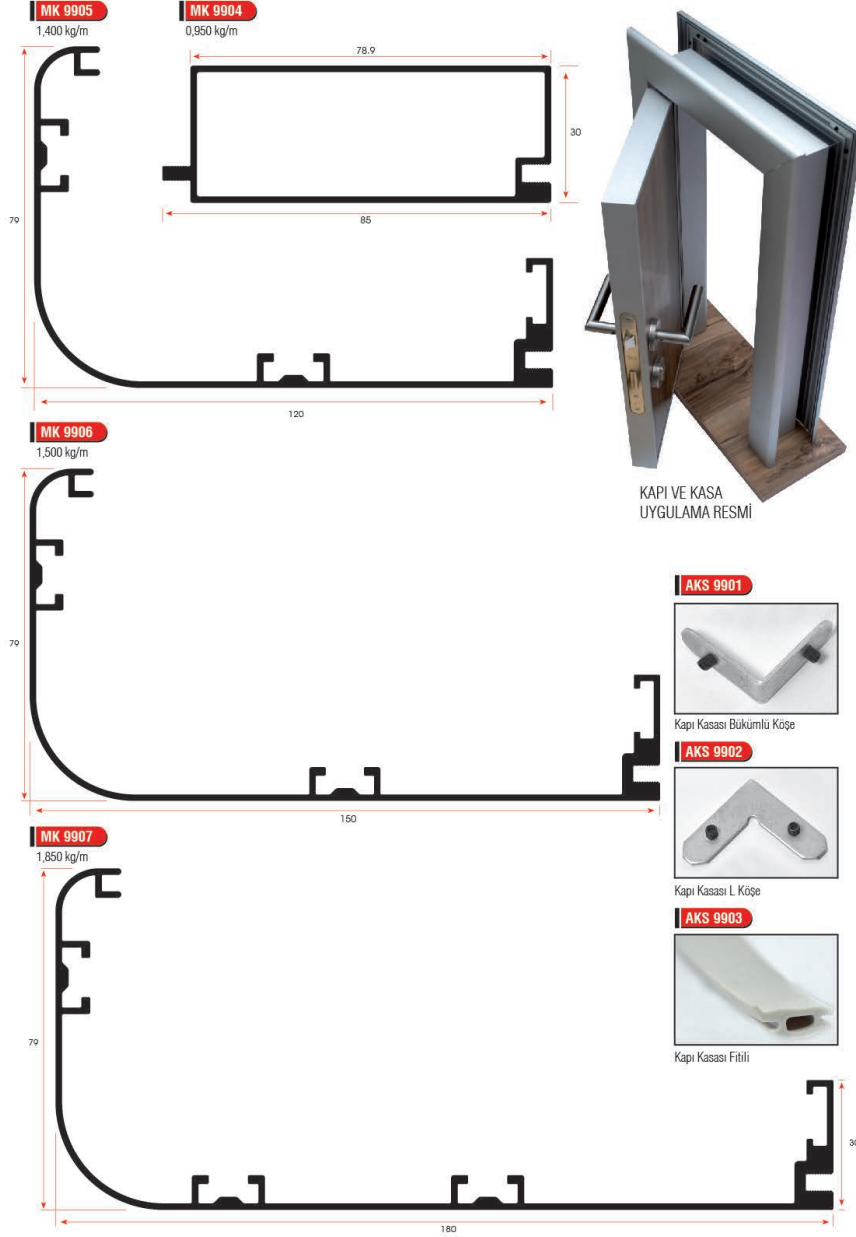

MEKANİZMA/MECHANISM

80 kg Yavaşlatıcı Kapı Askı Mekanizması 80 kg. Hanging Door Mechanism With Soft Close

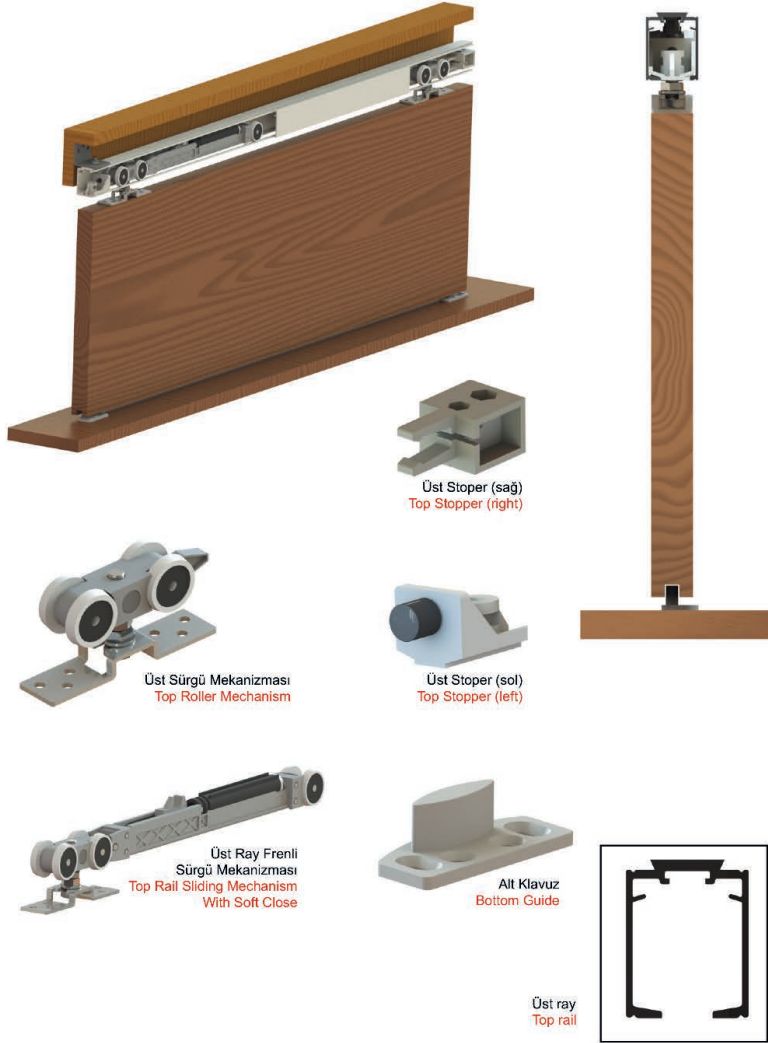

80 kg Kapı Askı Mekanizması
80 kg. Hanging Door Mechanism

80kg. taşıma kapasitesindedir.18 mm sunta kapaklar için kullanılır.Poliamid tekerlekli, hareketli mafsallı 15 mm yükseklik ayarı yapılabilen kapı kapak sistemi.



80kg. carrying capacity.
Use for 18 mm chipboard. 15 mm height adjustable, hinged door system with polyamide roller.

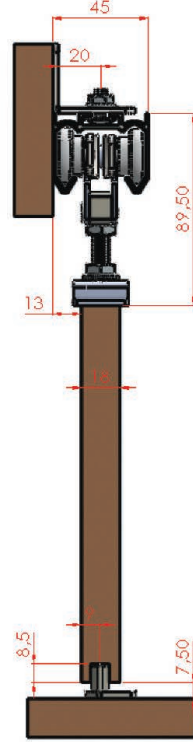

Kapı Üst Makarası
Door Top Roller



Alt Klavuz Elemanı
Bottom Guide Component



Üst ray asma aparatı
Top rail hanging device



Kapı Üst Stoperi
Door Top Stopper

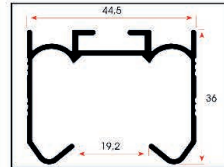

Üst Ray
Top Rail

MEKANİZMA/MECHANISM

51 kg Kapı Askı Mekanizması 51 kg. Hanging Door Mechanism

51 kg. taşıma kapasitesindedir. 28 mm sunta kapaklar için kullanılır. Poliamid tekerlekli, hareketli mafsallı 15 mm yükseklik ayarı yapılabilen kapı kapak sistemi.

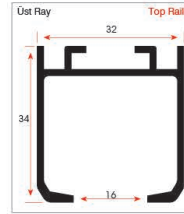
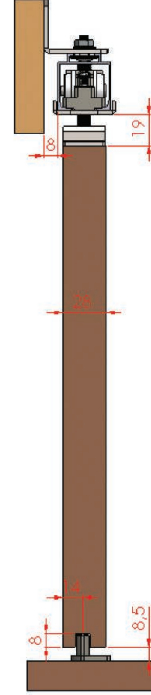



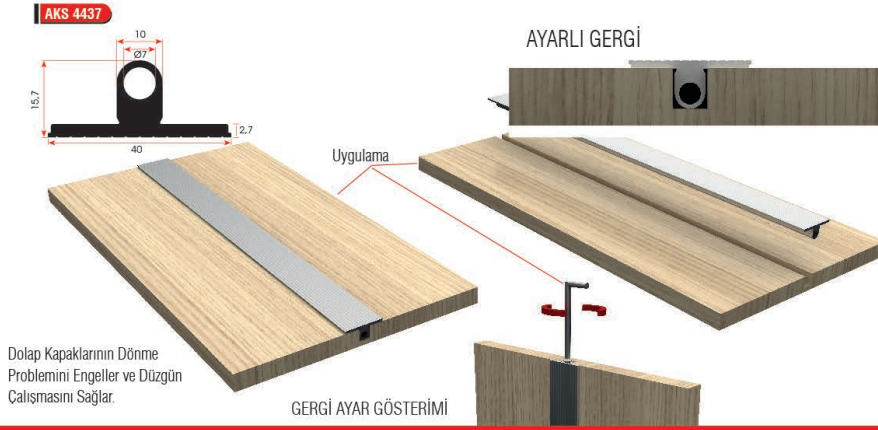



MEKANİZMA/MECHANISM

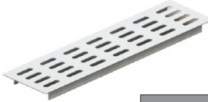
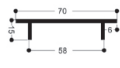

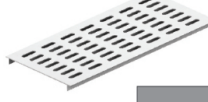
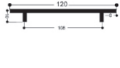
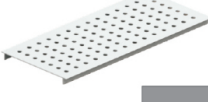
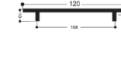
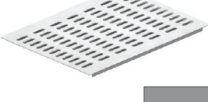
Dolap Kapaklarının Dönme Problemini Engeller ve Düzgün Çalışmasını Sağlar.

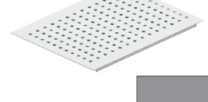
MENFEZ/VENT

Oval Delikli Menfez	Oval Punched Vent	Yuvarlak Delikli Menfez	Round Punched Vent																						
  <table border="1"> <thead> <tr> <th>(A) Ölçüsü (A) Measure</th> <th>Boy Ölçüsü Length</th> </tr> </thead> <tbody> <tr> <td>7'lik MENFEZ / Vent</td> <td>270 mm</td> </tr> <tr> <td>70 mm</td> <td>423 mm</td> </tr> <tr> <td>70 mm</td> <td>500 mm</td> </tr> <tr> <td>70 mm</td> <td>610 mm</td> </tr> <tr> <td>70 mm</td> <td>763 mm</td> </tr> </tbody> </table>	(A) Ölçüsü (A) Measure	Boy Ölçüsü Length	7'lik MENFEZ / Vent	270 mm	70 mm	423 mm	70 mm	500 mm	70 mm	610 mm	70 mm	763 mm	  <table border="1"> <thead> <tr> <th>(A) Ölçüsü (A) Measure</th> <th>Boy Ölçüsü Length</th> </tr> </thead> <tbody> <tr> <td>7'lik MENFEZ / Vent</td> <td>270 mm</td> </tr> <tr> <td>70 mm</td> <td>423 mm</td> </tr> <tr> <td>70 mm</td> <td>500 mm</td> </tr> <tr> <td>70 mm</td> <td>610 mm</td> </tr> <tr> <td>70 mm</td> <td>763 mm</td> </tr> </tbody> </table>	(A) Ölçüsü (A) Measure	Boy Ölçüsü Length	7'lik MENFEZ / Vent	270 mm	70 mm	423 mm	70 mm	500 mm	70 mm	610 mm	70 mm	763 mm
(A) Ölçüsü (A) Measure	Boy Ölçüsü Length																								
7'lik MENFEZ / Vent	270 mm																								
70 mm	423 mm																								
70 mm	500 mm																								
70 mm	610 mm																								
70 mm	763 mm																								
(A) Ölçüsü (A) Measure	Boy Ölçüsü Length																								
7'lik MENFEZ / Vent	270 mm																								
70 mm	423 mm																								
70 mm	500 mm																								
70 mm	610 mm																								
70 mm	763 mm																								
  <table border="1"> <thead> <tr> <th>(A) Ölçüsü (A) Measure</th> <th>Boy Ölçüsü Length</th> </tr> </thead> <tbody> <tr> <td>12'lik MENFEZ / Vent</td> <td>270 mm</td> </tr> <tr> <td>120 mm</td> <td>423 mm</td> </tr> <tr> <td>120 mm</td> <td>500 mm</td> </tr> <tr> <td>120 mm</td> <td>610 mm</td> </tr> <tr> <td>120 mm</td> <td>763 mm</td> </tr> </tbody> </table>	(A) Ölçüsü (A) Measure	Boy Ölçüsü Length	12'lik MENFEZ / Vent	270 mm	120 mm	423 mm	120 mm	500 mm	120 mm	610 mm	120 mm	763 mm	  <table border="1"> <thead> <tr> <th>(A) Ölçüsü (A) Measure</th> <th>Boy Ölçüsü Length</th> </tr> </thead> <tbody> <tr> <td>12'lik MENFEZ / Vent</td> <td>270 mm</td> </tr> <tr> <td>120 mm</td> <td>423 mm</td> </tr> <tr> <td>120 mm</td> <td>500 mm</td> </tr> <tr> <td>120 mm</td> <td>610 mm</td> </tr> <tr> <td>120 mm</td> <td>763 mm</td> </tr> </tbody> </table>	(A) Ölçüsü (A) Measure	Boy Ölçüsü Length	12'lik MENFEZ / Vent	270 mm	120 mm	423 mm	120 mm	500 mm	120 mm	610 mm	120 mm	763 mm
(A) Ölçüsü (A) Measure	Boy Ölçüsü Length																								
12'lik MENFEZ / Vent	270 mm																								
120 mm	423 mm																								
120 mm	500 mm																								
120 mm	610 mm																								
120 mm	763 mm																								
(A) Ölçüsü (A) Measure	Boy Ölçüsü Length																								
12'lik MENFEZ / Vent	270 mm																								
120 mm	423 mm																								
120 mm	500 mm																								
120 mm	610 mm																								
120 mm	763 mm																								
  <table border="1"> <thead> <tr> <th>(A) Ölçüsü (A) Measure</th> <th>Boy Ölçüsü Length</th> </tr> </thead> <tbody> <tr> <td>20'lik MENFEZ / Vent</td> <td>270 mm</td> </tr> <tr> <td>200 mm</td> <td>423 mm</td> </tr> <tr> <td>200 mm</td> <td>500 mm</td> </tr> <tr> <td>200 mm</td> <td>610 mm</td> </tr> <tr> <td>200 mm</td> <td>763 mm</td> </tr> </tbody> </table>	(A) Ölçüsü (A) Measure	Boy Ölçüsü Length	20'lik MENFEZ / Vent	270 mm	200 mm	423 mm	200 mm	500 mm	200 mm	610 mm	200 mm	763 mm	  <table border="1"> <thead> <tr> <th>(A) Ölçüsü (A) Measure</th> <th>Boy Ölçüsü Length</th> </tr> </thead> <tbody> <tr> <td>20'lik MENFEZ / Vent</td> <td>270 mm</td> </tr> <tr> <td>200 mm</td> <td>423 mm</td> </tr> <tr> <td>200 mm</td> <td>500 mm</td> </tr> <tr> <td>200 mm</td> <td>610 mm</td> </tr> <tr> <td>200 mm</td> <td>763 mm</td> </tr> </tbody> </table>	(A) Ölçüsü (A) Measure	Boy Ölçüsü Length	20'lik MENFEZ / Vent	270 mm	200 mm	423 mm	200 mm	500 mm	200 mm	610 mm	200 mm	763 mm
(A) Ölçüsü (A) Measure	Boy Ölçüsü Length																								
20'lik MENFEZ / Vent	270 mm																								
200 mm	423 mm																								
200 mm	500 mm																								
200 mm	610 mm																								
200 mm	763 mm																								
(A) Ölçüsü (A) Measure	Boy Ölçüsü Length																								
20'lik MENFEZ / Vent	270 mm																								
200 mm	423 mm																								
200 mm	500 mm																								
200 mm	610 mm																								
200 mm	763 mm																								
 <p>Özel Havalandırma Menfezi Production in custom measures is possible</p> <table border="1"> <thead> <tr> <th>(A) Ölçüsü (A) Measure</th> <th>Boy Ölçüsü Length</th> </tr> </thead> <tbody> <tr> <td>100'lük MENFEZ / Vent</td> <td>200 mm</td> </tr> <tr> <td>100 mm</td> <td>300 mm</td> </tr> <tr> <td>100 mm</td> <td>400 mm</td> </tr> <tr> <td>100 mm</td> <td>500 mm</td> </tr> <tr> <td>100 mm</td> <td>600 mm</td> </tr> <tr> <td>100 mm</td> <td>700 mm</td> </tr> <tr> <td>100 mm</td> <td>800 mm</td> </tr> </tbody> </table>	(A) Ölçüsü (A) Measure	Boy Ölçüsü Length	100'lük MENFEZ / Vent	200 mm	100 mm	300 mm	100 mm	400 mm	100 mm	500 mm	100 mm	600 mm	100 mm	700 mm	100 mm	800 mm	<p>Special Air Vent</p>								
(A) Ölçüsü (A) Measure	Boy Ölçüsü Length																								
100'lük MENFEZ / Vent	200 mm																								
100 mm	300 mm																								
100 mm	400 mm																								
100 mm	500 mm																								
100 mm	600 mm																								
100 mm	700 mm																								
100 mm	800 mm																								



DECO LIGNUM

ORMAN ÜRÜNLERİ

Office Adres: Yeşilirmak Caddesi No:10 Kat 2/5 Azizoglu Plaza KEPEZ / ANTALYA

Gsm: +90 533 594 06 76 / 0542 480 0765

E-Posta: info@decolignum.com.tr

www.decolignum.com

